

SEM 4004 and SEM 4005 / SEP 300 & SEP 350

Final Report Team 5

Setup, Integration, Operation, Testing and Data

Autonomous Fixed Wing Drone

Project Supervisor: Dr Wee Liang Boon

Name	Student number
Ahmad Faruq Bin Ahmad Zafir	1800747
Michel Shane Keh	1801271
Muhammad Iskandar Bin Ishak	1800786
Muhammad Syahiddin Bin Mahadi	1802690

Abstract

The Capstone project is a final year project every Systems Engineering Electromechanical Systems (SEEMS) student will undergo as part of their final assessment in the program. Spanning two trimesters, students are expected to work in groups to design, build, document, and test their projects based on the knowledge and experience they have acquired throughout their university term.

The autonomous fixed wing drone project is an industry project which we have decided to undertake in conjunction with JTC and SIT, where the fixed wing drone shall be autonomous and have a minimum flight endurance of an hour for the purpose of security observation. The autonomous fixed wing drone includes a payload of a wireless camera including beyond line-of-sight capabilities as well as launch and recovery capabilities.

This report will detail the final progress of an Autonomous Fixed Wing Drone project for Jurong Town Corporation (JTC). This report is a continuation from the previous trimester report, where this report describes the setup and integration of the fixed wing drone and serves as an operation manual too. This report shall encapsulate the different sections such as the setup, calibration and testing of components, integration, operations and testing procedure.



List of Abbreviations

Acronym	Definition
BEC	Battery Elimination Circuit
BOM	Bill of Materials
CAAS	Civil Aviation Authority of Singapore
CG	Centre of Gravity
FPV	First Person View
FCU	Flight Control Unit
GCS	Ground Control Station
GPS	Global Positioning System
IMDA	Infocomm Media Development Authority
JTC	Jurong Town Corporation
PDB	Power Distribution Board
RC	Radio Control
UAV	Unmanned Aerial Vehicle
VTOL	Vertical Takeoff and Landing
WBS	Work Breakdown Structure

List of Figures

Figure 1: Fixed Wing Drone	10
Figure 2: Layouts of parts of SonicModell Skyhunter 1800.....	13
Figure 3: Wings + Elevator Assembled	13
Figure 4: Fuselage assembled	13
Figure 5: Motor mounted at the rear of the fuselage with propellers mounted to the motor hub.	14
Figure 6: PDB + Pixhawk 4 + ESC + XBee mounted onto the PVC.....	14
Figure 7: Servo motors mounted on the wings + elevator.....	14
Figure 8: GPS and Receiver secured to the fuselage via velcro tape	15
Figure 9: Wing spars connected to the wing circled in red.....	15
Figure 10: Magnets used to secure the nose cover	15
Figure 11: Wings secured to the fuselage via screws.....	16
Figure 12: Wiring and connection required for UAV	16
Figure 13: Wiring of RC receiver to Pixhawk 4	17
Figure 14: Incorrect wiring of RC receiver to Pixhawk 4	17
Figure 15: Reference for the wiring the XBee module can be found in the ArduPilot documentation	18
Figure 16: Connection from XBee to Pixhawk 4	19
Figure 17: Detailed connection ESC/BEC output to servo rail and to servo motors	19
Figure 18: Simplified connection of ESC/BEC output to servo rail and to servo motors.....	20
Figure 19: PM07 Board connection to Pixhawk 4 to GPS module	20
Figure 20: Connection of motor wiring to the ESC.....	21
Figure 21: Discovery of XBee module on PC	22
Figure 22: XBee physical Mac Address label or through XCTU.....	23
Figure 23: Address of the XBee to be connected	23
Figure 24: Coordinator Enable parameters	24
Figure 25: Baud rate setting for XBee	24
Figure 26: XBee Control Ribbon	24
Figure 27: Firmware installation for ArduPilot/ArduPlane	25
Figure 28: Connect and set correct baud rate of 115200 to connect to Pixhawk 4 via USB.....	25
Figure 29: Linking procedure for FUTABA receiver and transmitter from datasheet	26
Figure 30: Selecting Linkage.....	27
Figure 31: Select Model type.....	27
Figure 32: Airplane Model	28
Figure 33: Airplane Selection	28
Figure 34: Aileron Selection	28
Figure 35: Linkage Menu	29
Figure 36: Select Function	29
Figure 37: Mapping of functions to channels and controls 1	29
Figure 38: Mapping of functions to channels and controls 2.....	30
Figure 39: Mapping of functions to channels and controls 3.....	30
Figure 40: Mapping of functions to channels and controls 4.....	30
Figure 41: 3D fix status on HUD.....	31

Figure 42: Accelerometer calibration page	32
Figure 43: Orientation reference for Acceleration calibration	32
Figure 44: Compass Calibration	33
Figure 45: Radio Calibration	33
Figure 46: Programming the throttle stick for transmitter	34
Figure 47: Servo Motor Output	34
Figure 48: FLTMODE_CH parameter	35
Figure 49: Flight Mode Configuration	35
Figure 50: Battery Monitor	35
Figure 51: RC5_OPTION variable	36
Figure 52: Insertion of PVC board into the fuselage	37
Figure 53: Pushing the PVC into the fuselage	38
Figure 54: Top View of the fuselage	38
Figure 55: PVC slid back to the edge	39
Figure 56: Side View of CG testing with 2 points on the wing	40
Figure 57: Rear View of CG testing with 2 points on the wing	40
Figure 58: Toggle the right toggle stick to the right	43
Figure 59: To roll drone to the right	43
Figure 60: Toggle the right toggle stick to the left	44
Figure 61: To roll drone to the left	44
Figure 62: Minimum Throttle activated	44
Figure 63: Toggle the right toggle stick down	45
Figure 64: To pitch downwards	45
Figure 65: Toggle the right toggle stick up	45
Figure 66: To pitch upwards	45
Figure 67: Arm and Disarm Toggle Switch	46
Figure 68: Flight Mode Toggle Switch	46
Figure 69: Autonomous planning on Mission Planner	47
Figure 70: Futaba Datasheet on RC and telemetry range testing	48
Figure 71: Safety Checklist	50
Figure 72: Old Holland Road Route	51
Figure 73: Hand Throwing take-off	52
Figure 74: Attempt to hand throw take-off	52
Figure 75: Conducting of pre-flight checks	54
Figure 76: Snippet of UAV Log Viewer	55
Figure 77: STAT.isFlying vs Time	56
Figure 78: GPS.Spd vs Time	56
Figure 79: Current Drawn and Throttle vs Time	57
Figure 80: Barometer, GPS, and Canonical Calculated Altitude vs Time	57
Figure 81: Power Consumption vs Time	58
Figure 82: Voltage, Measured Volt vs Time	58
Figure 83: Console Messages	59
Figure 84: Autonomous Drone Flight	61
Figure 85: Autonomous Drone Flight with ArduPilot	62

Figure 86: Autonomous Fixed Wing Drone flying in Old Holland Road Big Field	62
Figure 87: GPS Speed vs Flight Time	63
Figure 88: Voltage Measurement vs Time.....	63
Figure 89: Power Consumption vs Flight Time.....	64
Figure 90: Troubleshooting during flight test	66

List of Tables

Table 1: Drone Specifications	11
Table 2: BOM List	12
Table 3: SBUS RC Pins from Pixhawk 4	18
Table 4: List of programs/software required for the project.....	22
Table 5: MAC Addresses and Functions used	24
Table 6: Channel Mapping	31
Table 7: List of Controls	46
Table 8: Metrics monitored during flight.....	53
Table 9: Planned Flight Tests.....	60
Table 10: Stakeholder Requirements	67

Table of Contents

Abstract.....	2
List of Abbreviations.....	3
List of Figures	4
List of Tables	6
Table of Contents.....	7
1. Executive Summary	10
2. Drone Specifications	11
3. Setup	11
3.1. BOM List.....	11
3.2. Mechanical Assembly	12
3.3. Wiring Diagram	16
3.4. Detailed wiring	17
3.4.1. Radio Control (RC) connection	17
3.4.2. XBee connection.....	18
3.4.3. PM07 connection (Servo Rail and ESC)	19
3.4.4. PM07 connection (PM07, Pixhawk 4 and GPS module).....	20
3.4.5. Motor to ESC Connection	21
3.5. Programs	21
3.5.1. XBee Setup	22
3.5.2. Mission Planner Setup and ArduPilot firmware	25
3.6. RC Setup	26
3.6.1. Linkage of RC transmitter and Receiver.....	26
3.6.2. Selecting the airplane type on the FUTABA transmitter	27
3.6.3. Channel mapping on the FUTABA transmitter	29
4. ArduPilot Configuration and Calibration	31
4.1. GPS Fix Test	31
4.2. Accelerometer Calibration.....	32
4.3. Compass Calibration.....	33
4.4. Radio Calibration	33
4.5. ESC Calibration	34
4.6. Servo Motor Output.....	34

4.7.	Flight Modes	34
4.8.	Battery Monitor	35
4.9.	Arm and Disarm Switch	35
4.10.	SD Card for Logging Flight Data.....	36
5.	Integration.....	37
5.1.	Integration Assembly	37
5.2.	Finding Center of Gravity (CG) of RC Aircraft	40
5.3.	Integration Test.....	41
6.	Operations	43
6.1.	RC Operation (Manual).....	43
6.1.1.	Rolling.....	43
6.1.2.	Throttling.....	44
6.1.3.	Pitching.....	45
6.1.4.	Additional features	46
6.2.	Autonomous Operation	47
7.	Testing Procedure.....	48
7.1.	Prior to flight.....	48
7.1.1.	Safety and Risk Checklist	49
7.1.2.	Route Planning (Holland).....	51
7.2.	During Flight	52
7.2.1.	Take-off Method: Hand Launch.....	52
7.2.2.	Metrics	53
8.	Manual Flight Test	54
8.1.	Pre-Flight Planning and Prerequisites.....	54
8.2.	Data Collation from Manual Flight Test	54
8.3.	Post Flight Analysis from Manual Flight	59
9.	Autonomous Testing	60
9.1.	Preparation	60
9.2.	Autonomous Flight Test	61
9.3.	Data Collation from Autonomous Flight Test	63
9.4.	Post Flight Analysis for Autonomous Flight	64
10.	Extending Future Flight Endurance	65
10.1.	Maintaining Specifications	65

10.2.	Changing Specifications	66
11.	Summary.....	67
12.	Conclusion	68
13.	References.....	68

1. Executive Summary

The purpose of this document is to present a final update on our progress in developing an autonomous fixed wing drone as part of our capstone project in Singapore Institute of Technology which we are required to undertake in our final year.

The autonomous fixed wing drone project is an industry project which we have decided to undertake in conjunction with JTC and SIT, where the fixed wing drone shall be autonomous and have a minimum flight endurance of an hour for the purpose of security observation. The autonomous fixed wing drone includes a payload of a wireless camera including beyond line-of-sight capabilities as well as launch and recovery capabilities.

This document serves as an integration, setup, and operation manual of the fixed wing drone along with the different sections such as the Setup, ArduPilot Configuration and Calibration, Integration, Operations and Testing Procedure. The Setup section consists of the BOM List, Mechanical Assembly, Overall and Detailed wiring, Programs and RC Setup. The ArduPilot Configuration and Calibration section describes the different calibration peripherals needed. Next, the Integration section describes the integration of the mechanical, electronic and program configuration setup. The Operations section describes the manual of the fixed wing drone and how to operate it. Lastly, the Testing Procedure describes the procedures required before conducting the flight of the fixed wing drone.



Figure 1: Fixed Wing Drone

2. Drone Specifications

This section describes the specifications of the autonomous fixed wing drone

Description:

Brand name:	SONICMODELL
Item Name:	Full Scale Specifications
Wingspan:	1800mm/70.86 in
Length:	1400mm/55.11 in (adjustable)
Wing Area:	36dm/3.9 ft^2
Weight:	3.5kg
Centre of Gravity:	1/3 of wing from leading edge
Material:	EPO + Carbon Fiber
Electronic Speed Controller:	45A
Motor:	DualSky ECO 2820C-V2 940kv 480W 45A 4S10X5
Propeller:	Aero-Naut CAM-CARBON 12x6
Aileron Servo:	DualSky DS395, Micro Digital, 9g, 1.5kg.cm at 6V
Elevator Servo:	TS-D6011 SERVO (1.6Kg/0.1S)
Battery:	Lipo, Zolta 25C 4S1P 10000mAh

Table 1: Drone Specifications

3. Setup

This section shall describe the Setup of the fixed wing drone project, which will consist of the Bill of Material List, Mechanical Assembly, Overall Wiring, Detailed Wiring and RC Setup. Each section shall describe how the drone is assembled, wired, and integrated.

3.1. BOM List

No.	Name	Description	Quantity
1	Skyhunter 1800mm Wingspan EPO Long Range FPV UAV Platform RC Airplane KIT	Drone	1
2	DualSky ECO 2820C-V2 940kv 480W 45A 4S10X5	Motor + motor accessories	1
3	Aero-Naut CAM-CARBON 12x6	Propellers	2
4	Aero-Naur Folding Prop Hub 38mm	Motor Hub	1
5	Lipo, Zolta 25C 4S1P 10000mAh	Battery	1
6	DualSky DS395, Micro Digital, 9g, 1.5kg.cm at 6V	Servo Motors for Ailerons	2
7	TS-D6011 SERVO (1.6Kg/0.1S)	Servo Motor for Elevator	1
8	DualSky XC-45-LITE, 45A, 2-3 LIPO, ESC	Electronic Speed Controller (ESC)	1

9	HolyBro Pixhawk 4 Flight Controller	Flight Controller Unit (FCU)	1
10	M8N GPS Module	GPS Module	1
11	PM07	Power Distribution Board (PDB)	1
12	XT90(F) to XT60 (M) adapter	Connectors	1
13	XBee-PRO S2C Zigbee	Wireless Module	2
14	SparkFun XBee Explorer Dongle USB	Adapter for PC	1
15	SparkFun XBee Explorer	Adapter to Pixhawk 4	1
16	Futaba 16SZ Receiver	Receiver	1
17	Futaba 16SZ Transmitter	Transmitter	1
18	Nylon Standoffs	M3 x 3mm	8
19	Nylon Screws	M3 x 4mm	8
20	Nylon Nuts	M3	8
21	FOM FM25-08 Burdock	Velcro Tape	0.6m
22	3pin Male-Female Wires	Wires	As needed
23	PVC board	20cm x 10cm	1
24	Magnets	Magnets	2 pairs
25	CAAS CAAS UA Registration Label	Registration Label	1

Table 2: BOM List

3.2. Mechanical Assembly

The fixed wing drone can be mainly separated into 2 parts, the fuselage, and the wings. The assembly of both the fuselage and wings is relatively simple, and their reinforcement is done using adhesives such as contact adhesives, gorilla glue, Loctite and epoxy.

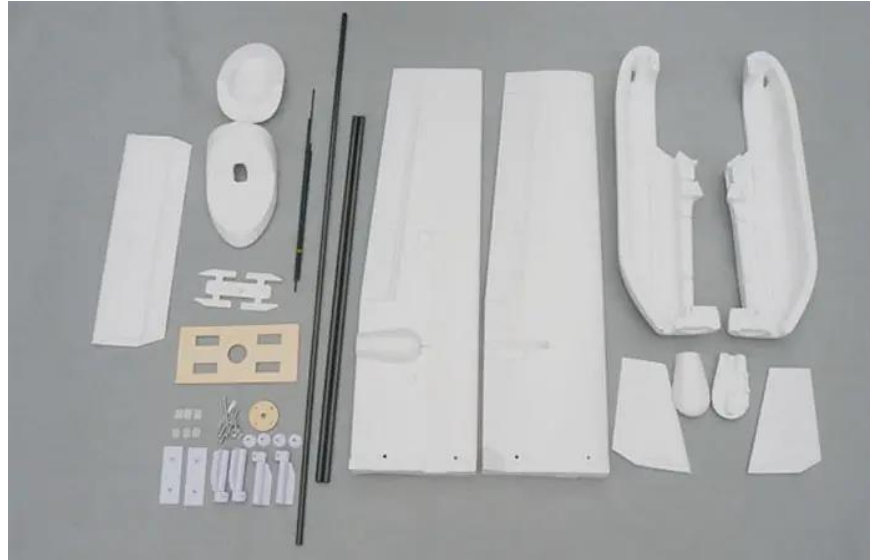

Figure 2: Layouts of parts of SonicModell Skyhunter 1800

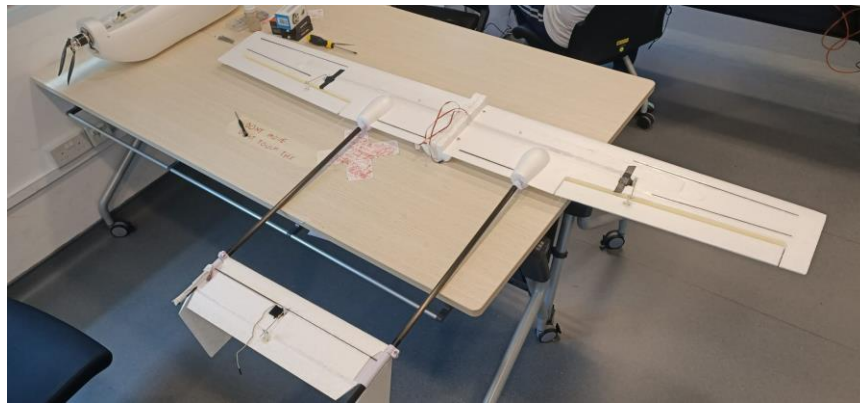

Figure 3: Wings + Elevator Assembled

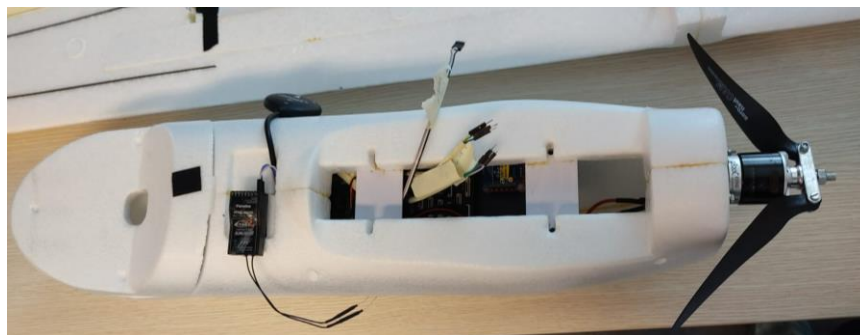

Figure 4: Fuselage assembled



Figure 5: Motor mounted at the rear of the fuselage with propellers mounted to the motor hub



Figure 6: PDB + Pixhawk 4 + ESC + XBee mounted onto the PVC



Figure 7: Servo motors mounted on the wings + elevator

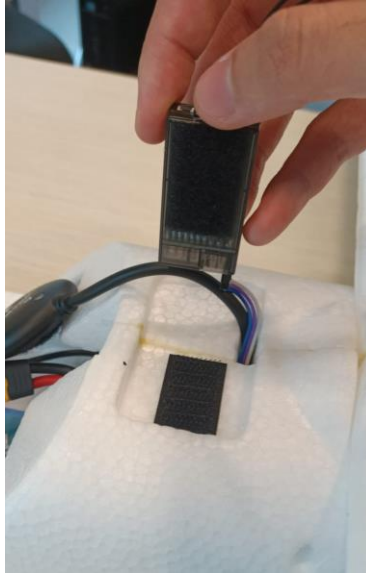

Figure 8: GPS and Receiver secured to the fueselage via velcro tape

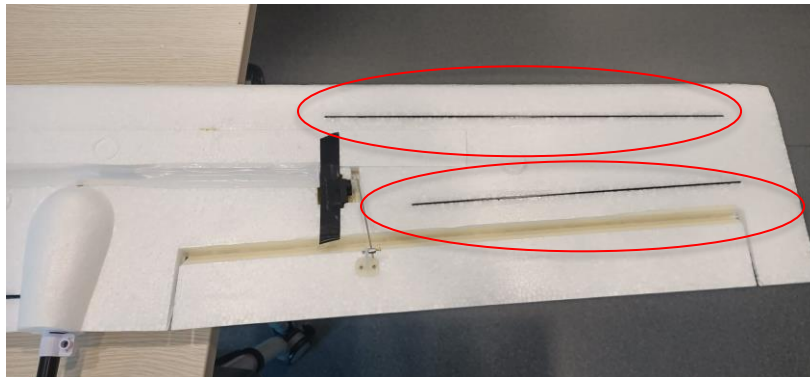

Figure 9: Wing spars connected to the wing circled in red



Figure 10: Magnets used to secure the nose cover

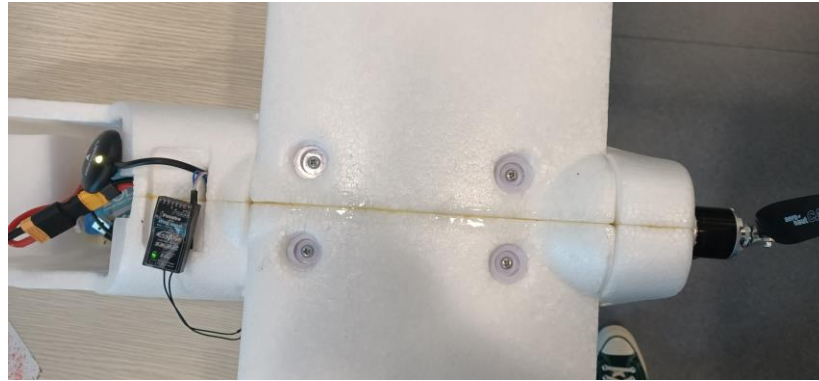

Figure 11: Wings secured to the fuselage via screws

3.3. Wiring Diagram

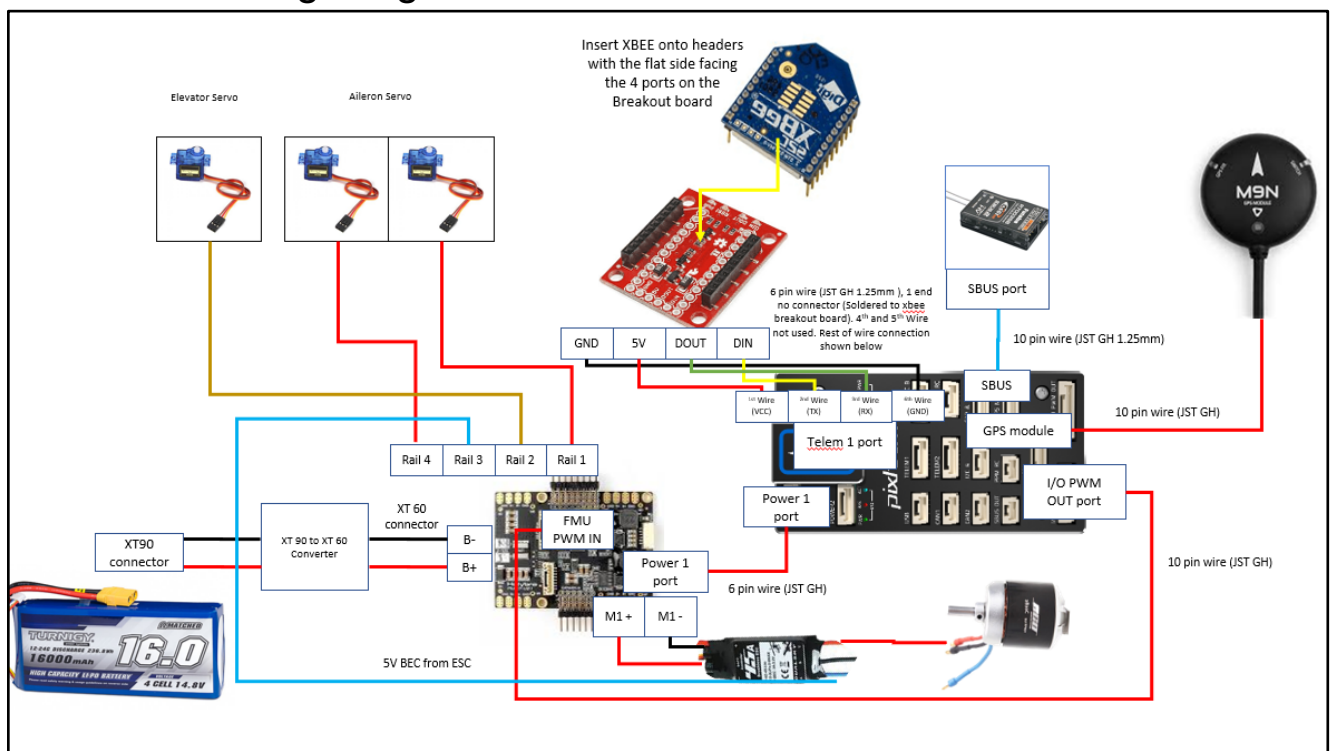

Figure 12: Wiring and connection required for UAV

The overall wiring of the fixed wing drone is as shown in Figure 12 above along with its connectors. It should be noted that some of the wires that are not being used are listed in the detailed wiring connections in the later sections.

In addition to this, servo motors and multi-pin connections are not displayed in this diagram to ensure the overall diagram is neat and clean. These connections will be shown in the later sections under the detailed wiring diagram section.

3.4. Detailed wiring

3.4.1. Radio Control (RC) connection

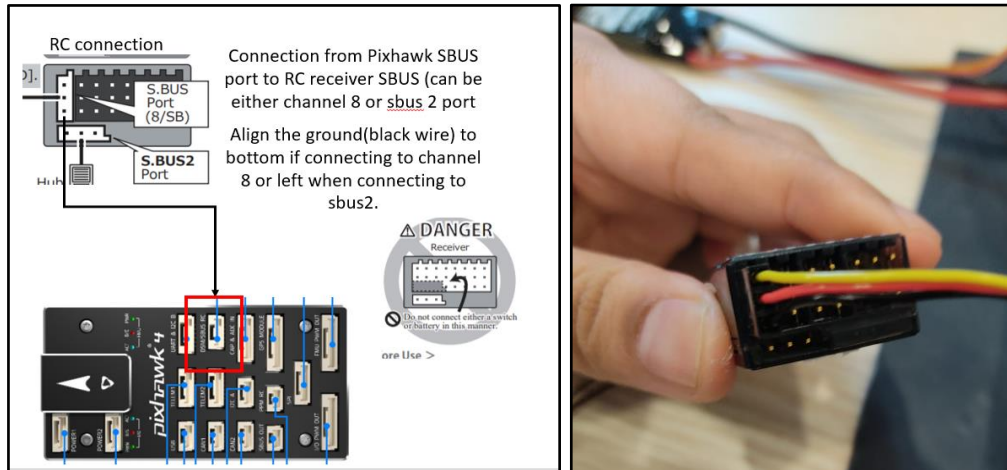

Figure 13: Wiring of RC receiver to Pixhawk 4

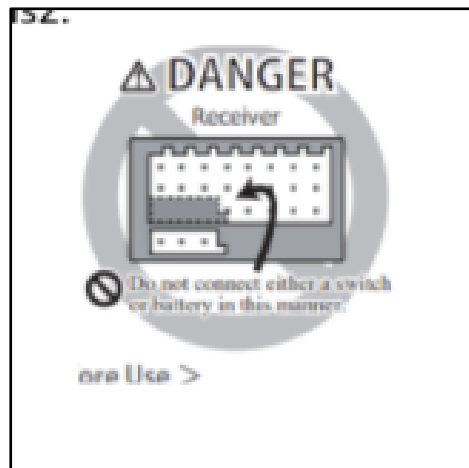

Figure 14: Incorrect wiring of RC receiver to Pixhawk 4

The Pixhawk 4 provides power to the Radio Control (RC) receiver via the SBUS. It is also imperative to note that the wires should not be connected horizontally as seen in the Figure 14 above.

3.4.2. XBee connection

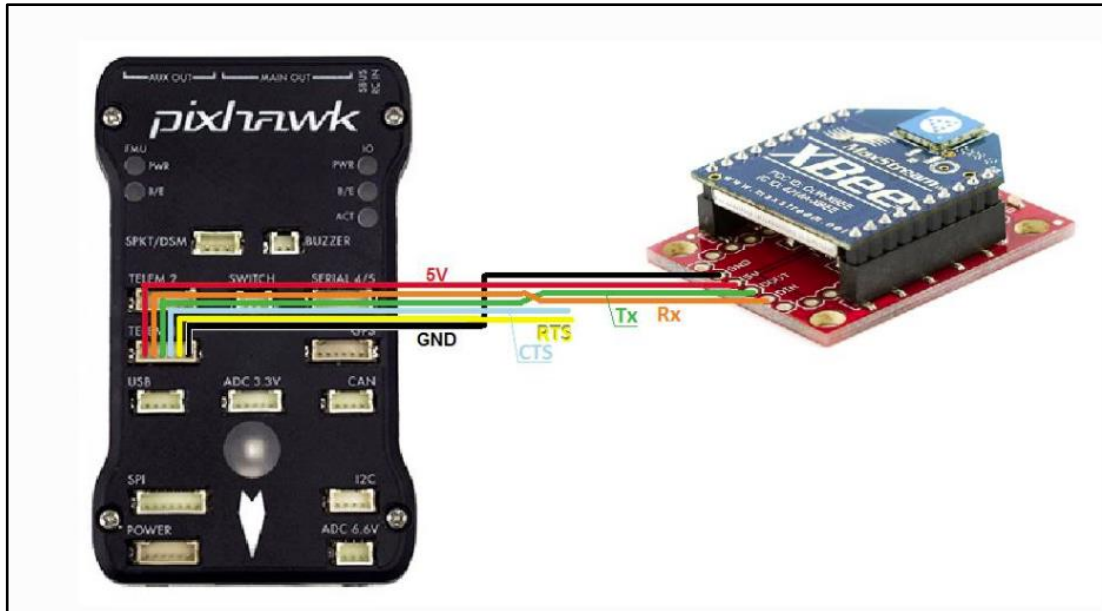

Figure 15: Reference for the wiring the XBee module can be found in the ArduPilot documentation

SBUS RC Pins from Pixhawk 4 (JST GH connector)	Signal	Connection to in XBee breakout board
1	VCC	5V
2	SBUS signal	DIN
3	Receiver strength Signal Indicator (RSSI)	DOUT
4	RTS	Not in use
5	CTS	Not in use
6	GND	GND

Table 3: SBUS RC Pins from Pixhawk 4

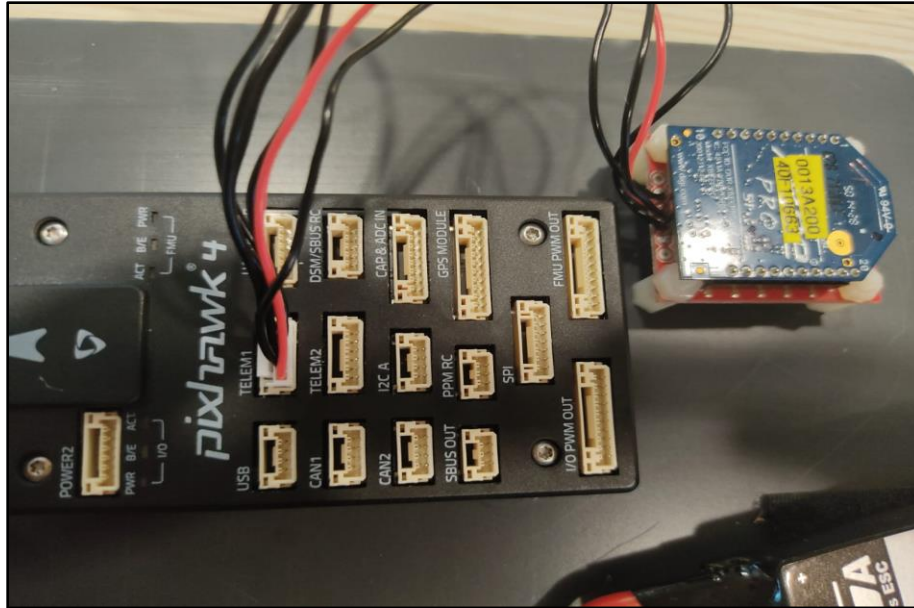

Figure 16: Connection from XBee to Pixhawk 4

To connect the wires from the XBee to the Pixhawk 4, we snipped off and removed the default JST-GH connector housing. The wires were then soldered onto the XBee breakout board and connected through the Telemetry port on the Pixhawk 4 flight controller. This is shown in Figure 16.

3.4.3. PM07 connection (Servo Rail and ESC)

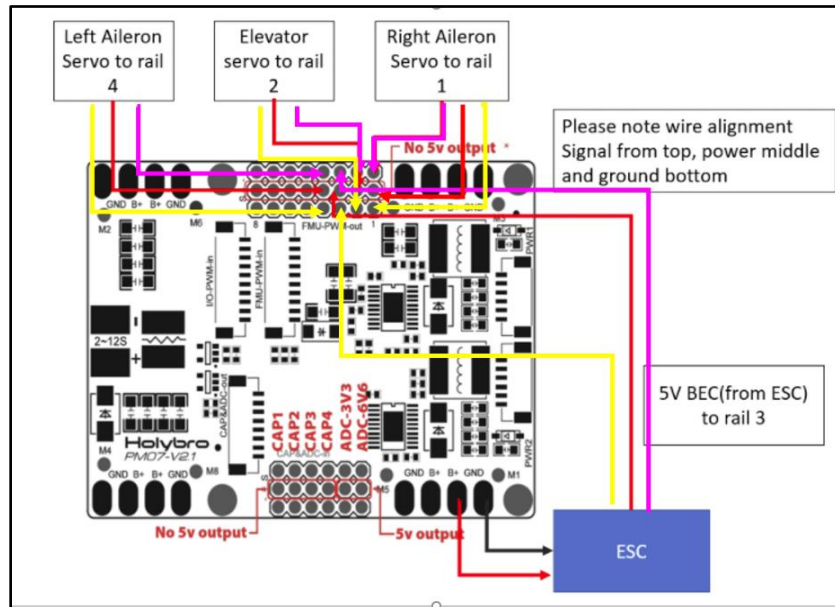

Figure 17: Detailed connection ESC/BEC output to servo rail and to servo motors

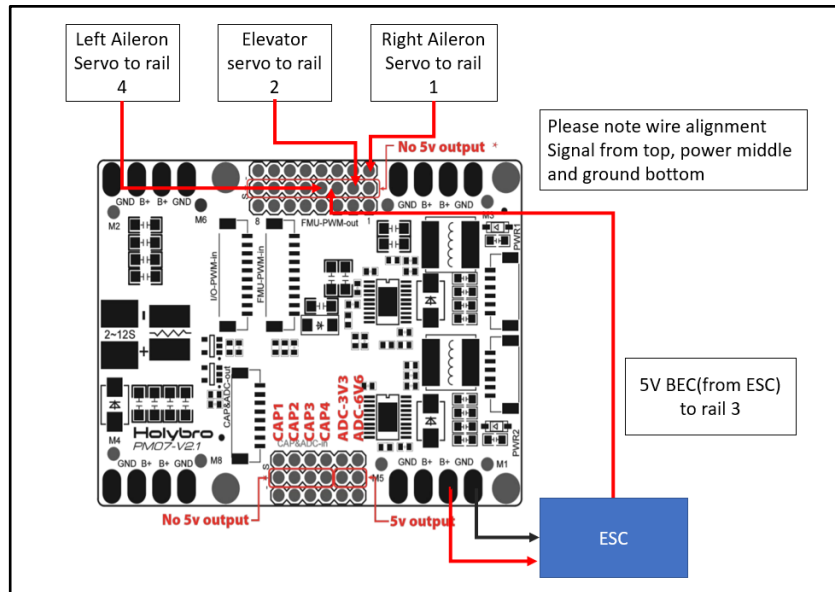

Figure 18: Simplified connection of ESC/BEC output to servo rail and to servo motors

As seen in Figure 18 above, the servo rail on the PM07 Power Distribution Board is powered by the ESC via the 5V BEC. Otherwise, the servo rail will not be powered up as it is connected through an auxiliary channel on the PDB instead of the main channel.

Note that on the diagram of the detailed version as seen in Figure 17 above, the yellow represents signal, power is red, and purple is ground.

3.4.4. PM07 connection (PM07, Pixhawk 4 and GPS module)

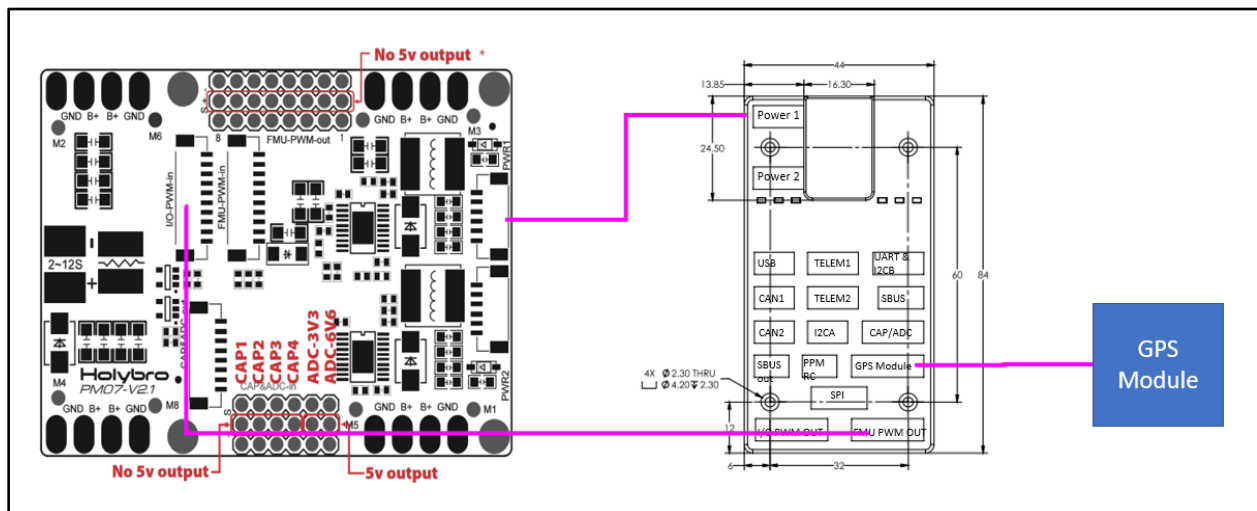

Figure 19: PM07 Board connection to Pixhawk 4 to GPS module

All connections between the PM07 PDB and the Pixhawk 4 are through JST GH connectors and are compatible with each other. If there is a need for customised wiring, please refer to the PM07, Pixhawk 4 pinout documents found on the Holybro website.

3.4.5. Motor to ESC Connection

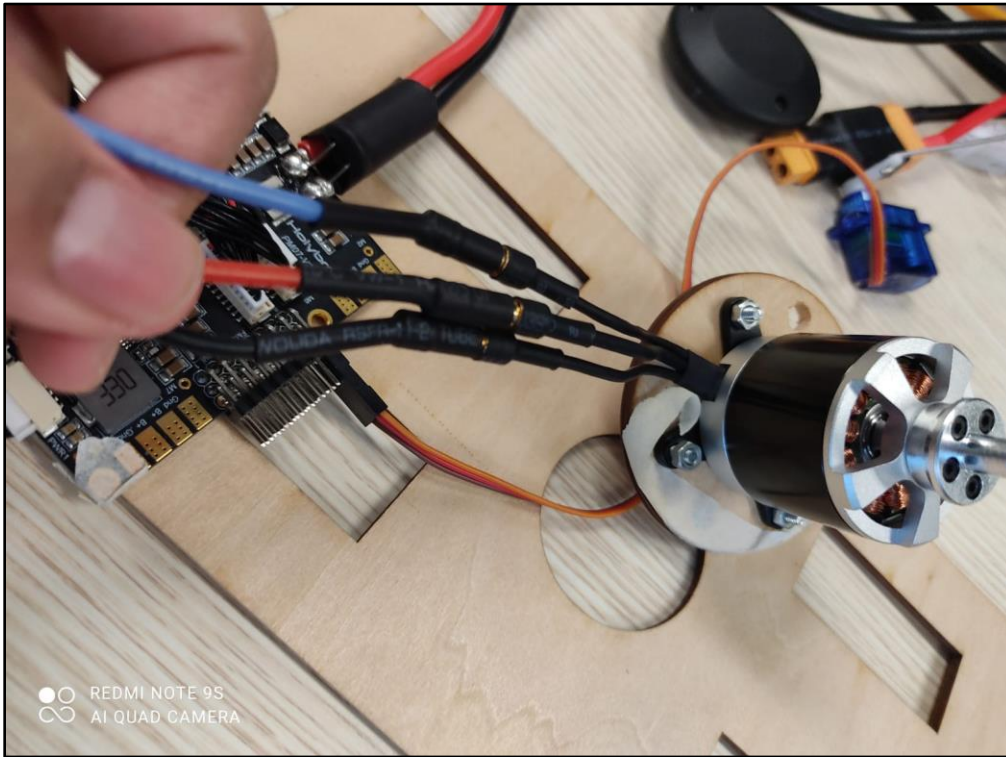

Figure 20: Connection of motor wiring to the ESC

Middle wire: Power (Connect to red), Labelled **P**
 Right wire: Signal (Connect to blue), Labelled **BL**
 Left wire: Ground (Connect to black), Labelled **BK**

Do note that the motor must spin clockwise, should the motor spin counterclockwise, swap any of the two wires (eg: BL with P)

3.5. Programs

Program	Website to download	Notes
XCTU for Xbee telemetry [1]	https://hub.digi.com/support/products/xctu/	- For XBee telemetry setup
Mission Planner [2]	https://firmware.ardupilot.org/Tools/MissionPlanner/	- Download the stable MSI file for Windows - Will have the software for software in the loop and ArduPilot firmware included
QGroundControl	https://docs.qgroundcontrol.com/master	- Used to flash px4 to

[3]	/en/getting_started/download_and_install.html	fully override the ArduPilot to ensure fresh install without compiling/building through (c-make) the source files from git
-----	---	--

Table 4: List of programs/software required for the project

3.5.1.XBee Setup

To set up the XBee module for telemetry XBee devices are required. One of the XBee modules is connected directly to the fixed wing drone and the other is connected to a personal computer (PC) which acts as a Ground Station. The steps to set up the XBee module are stated below.





XBee Setup	
Step	Task
1	Connect the first XBee to PC via USB port connection through the XBee explorer which is an attachment to the XBee module. The other device will be connected after finishing the steps in the setup.
2	<p>Using the XCTU platform on the computer, we then try to find the XBee connected to the PC. If installed correctly, it will be displayed on the COM port.</p>  <p>The screenshot shows the XCTU application window with a 'Discover radio devices' dialog box open. The dialog box has a title bar and contains the following text: 'Select the ports to scan', 'Select the USB/Serial ports of your PC to be scanned when discovering for radio modules.', and 'Select the ports to be scanned:'. Below this text is a list of ports, a 'Refresh ports' button, and 'Select all' and 'Deselect all' buttons. At the bottom of the dialog are '< Back', 'Next >', 'Finish', and 'Cancel' buttons. In the background, the main interface of the 'Radio Modules' section is visible, with a red box highlighting the 'Add devices or Discover devices to add radio modules to the list.' button.</p>

Figure 21: Discovery of XBee module on PC

<p>3</p>	<p>Set up parameters of the XBee connection through the XCTU platform (may refer to https://ardupilot.org/copter/docs/common-telemetry-xbee.html)</p>				
<p>4</p>	<p>Take note of address on the other XBee. This can be found from the underside label of the device.</p>				
<p>5</p>	<p>Take note of source address/MAC address. This can be found from the underside label of the device. This will be used as the destination address of the secondary XBee.</p> <div style="text-align: center;">  </div> <div style="text-align: center; border: 1px solid black; padding: 5px; margin: 10px auto; width: fit-content;"> <table border="1" style="width: 100%; border-collapse: collapse;"> <tr> <td style="width: 20%; text-align: center;"></td> <td style="padding: 5px;"> <p>Name: XBEEpc New Firmware</p> <p>Function: XBEE PRO 802.15.4</p> <p>Port: COM9 - 57600/8/N/1/N - AT</p> <p>MAC: 0013A20040F1066A</p> </td> <td style="width: 10%; text-align: center; vertical-align: middle;"> ✕ ↻ ▼ </td> </tr> </table> </div> <p style="text-align: center; font-size: small; color: blue;">Figure 22: XBee physical Mac Address label or through XCTU</p>		<p>Name: XBEEpc New Firmware</p> <p>Function: XBEE PRO 802.15.4</p> <p>Port: COM9 - 57600/8/N/1/N - AT</p> <p>MAC: 0013A20040F1066A</p>	✕ ↻ ▼	
	<p>Name: XBEEpc New Firmware</p> <p>Function: XBEE PRO 802.15.4</p> <p>Port: COM9 - 57600/8/N/1/N - AT</p> <p>MAC: 0013A20040F1066A</p>	✕ ↻ ▼			
<p>6</p>	<p>Input the destination Address High and Low accordingly (This address refers to the physical address found on the secondary XBee device). First 8 numbers from the left of the physical address are inputs for destination address high and the following 8 numbers are inputs for destination address low.</p> <div style="border: 1px solid gray; padding: 10px; margin: 10px auto; width: fit-content;"> <table style="width: 100%; border-collapse: collapse;"> <tr> <td style="width: 40%; padding: 5px;">i DH Destination Address High</td> <td style="padding: 5px;"><input style="width: 90%;" type="text" value="0113A200"/></td> </tr> <tr> <td style="padding: 5px;">i DL Destination Address Low</td> <td style="padding: 5px;"><input style="width: 90%;" type="text" value="40F1066A"/></td> </tr> </table> </div> <p style="text-align: center; font-size: small; color: blue;">Figure 23: Address of the XBee to be connected</p>	i DH Destination Address High	<input style="width: 90%;" type="text" value="0113A200"/>	i DL Destination Address Low	<input style="width: 90%;" type="text" value="40F1066A"/>
i DH Destination Address High	<input style="width: 90%;" type="text" value="0113A200"/>				
i DL Destination Address Low	<input style="width: 90%;" type="text" value="40F1066A"/>				

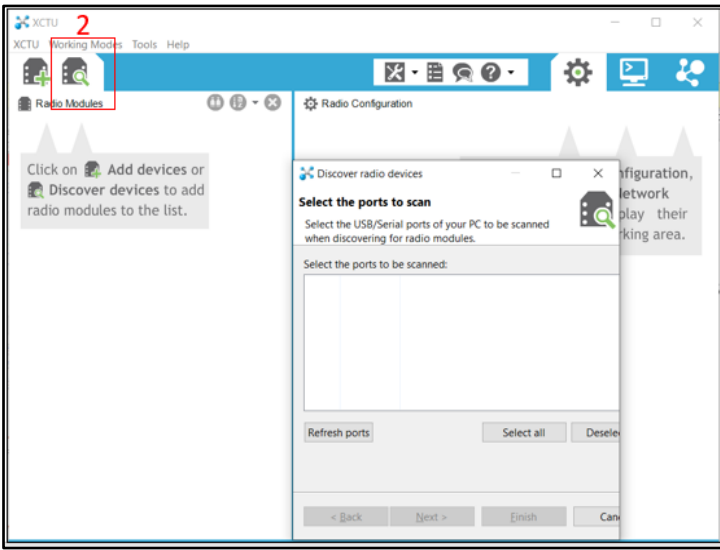
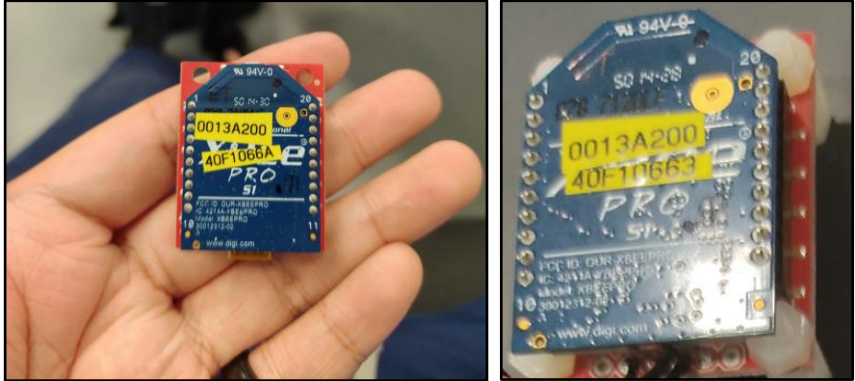
<p>7</p>	<p>The XBee device required for the fixed wing drone is set as the end device under coordinator enable (CE) parameters and the XBee device connected to the PC is set as the coordinator under the CE parameters.</p>  <p style="text-align: center;"><i>Figure 24: Coordinator Enable parameters</i></p>
<p>8</p>	<p>Ensure baud rate is set to 57600</p>  <p style="text-align: center;"><i>Figure 25: Baud rate setting for XBee</i></p>
<p>9</p>	<p>Once parameter inputs are completed, we can update the settings of the XBee device.</p>  <p style="text-align: center;"><i>Figure 26: XBee Control Ribbon</i></p>
<p>10</p>	<p>To verify that the parameters are successfully updated, we first disconnect the XBee connection and reconnect its connection to attempt to read the parameters. If written successfully, the updated parameters will be displayed in the parameter screen.</p>

The final setup that we used for this project using our XBee devices is shown in Table 5 below.

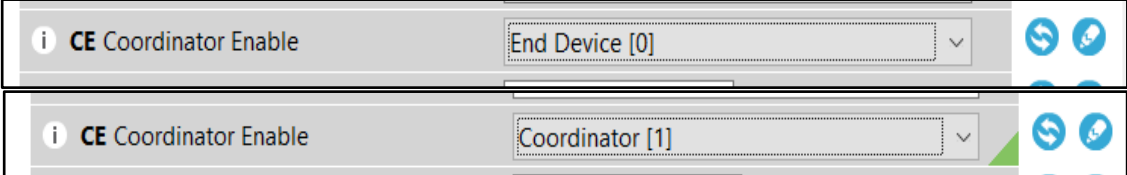
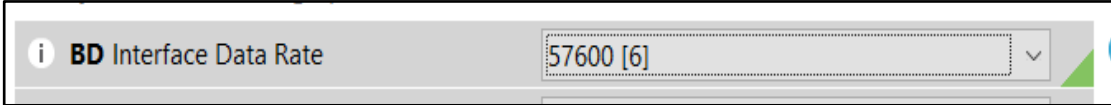
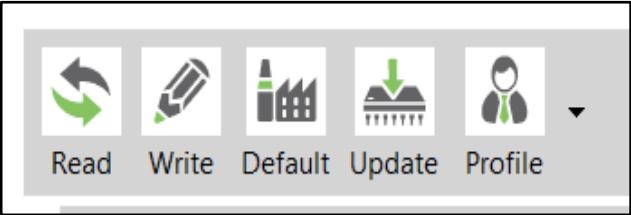
MAC Address	Function
0013A200 40F10663	XBee on the drone
0113A200 40F1066A	XBee on PC

Table 5: MAC Addresses and Functions used

3.5.2. Mission Planner Setup and ArduPilot firmware

Once Mission Planner program is installed, run the Microsoft installer of the program. This will install various drivers for the COM port during installation. Once installation is completed, we can refer to the steps below for setup.

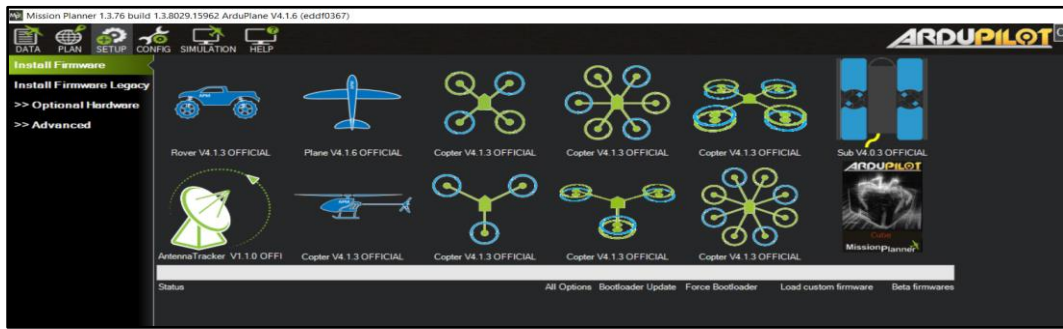
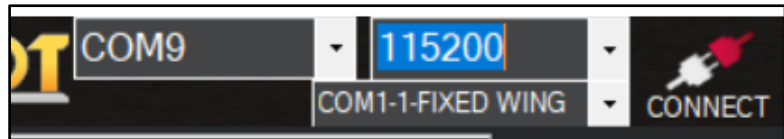
Mission Planner Setup and ArduPilot Firmware	
Step	Task
1	Launch Mission planner and direct yourself to the setup page. Connect the Pixhawk 4 via USB first. There is no need to click on the connect button yet.
2	Under the setup page, click on plane to install Arduplane on the Ard 4 flight controller. <div style="text-align: center;">  <p><i>Figure 27: Firmware installation for ArduPilot/ArduPlane</i></p> </div>
3	After installing arduplane on the Pixhawk 4, we can connect the Pixhawk 4 flight controller to the mission planner. The connect button is on the top right-hand corner of mission planner. Ensure that the baud rate is 115200 via COM port for USB. <div style="text-align: center;">  <p><i>Figure 28: Connect and set correct baud rate of 115200 to connect to Pixhawk 4 via USB</i></p> </div>
4	After connecting the Pixhawk 4 to Mission Planner platform, we can begin calibrating and integrating the components.
5	If there is ever a need to reset the firmware, we can try installing the px4 firmware into the Pixhawk 4 using Q Ground Control (QGC) and then re-installing arduplane firmware.

3.6. RC Setup

3.6.1. Linkage of RC transmitter and Receiver

Link procedure

- Place the transmitter and the receiver close to each other within half (0.5m) meter.
- Turn on the transmitter.
- Select [System type] at the Linkage menu and access the setup screen shown below by tapping the screen.
- When you use two receivers on one model, you must change from [Single] to [Dual].
*Only two receivers can be used. In "Dual", two setting items come out. Input, respectively.
- Battery fail-safe voltage can be changed from the initial value of 3.8V here.
* Only in FASSTest/T-FHSS Mode.
- [Link] is tapped. The transmitter will emit a chime as it starts the linking process.
- When the transmitter starts to chime, power on the receiver. The receiver should link to the transmitter within about 1 second.
- If linking fails, an error message is displayed. Bring the transmitter closer to the receiver and repeat the procedure above from Step 2.

Less than 0.5 m

System type	Model1 Condit1	6.7V
FASSTest 18CH	Receiver	Single
FASSTest 12CH	Receiver ID	Rx1
FASST MULTI	Link	Link
FASST 7CH	Telemetry	ACT
S-FHSS	D/L interval	1.0sec.
T-FHSS	B.F/S voltage	3.8V

System type	Model1 Condit1	6.7V
FASSTest 18CH	Receiver	Single
FASSTest 12CH	Receiver ID	Rx1
FASST MULTI	Link	Link
FASST 7CH	Telemetry	ACT
S-FHSS	D/L interval	1.0sec.
T-FHSS	B.F/S voltage	3.8V

System type	Model1 Condit1	6.7V
FASSTest 18CH	Receiver	Single
FASSTest 12CH	Linking	Turn on the receiver power.
FASST MULTI	Close	Close
FASST 7CH	Telemetry	ACT
S-FHSS	D/L interval	1.0sec.
T-FHSS	B.F/S voltage	3.8V

ID of a primary receiver displays. ID of a secondary receiver displays.

System type	Model1 Condit1	6.7V
FASSTest 18CH	Receiver	Dual
FASSTest 12CH	Receiver ID	Rx1: 11430003 Rx2: 11430003
FASST MULTI	Link	Link
FASST 7CH	Telemetry	ACT
S-FHSS	D/L interval	1.0sec.
T-FHSS	B.F/S voltage	3.8V 3.8V

In Dual, a primary receiver (Rx1) is linked first. Next, a secondary (Rx2) receiver is linked.

In "Link" Mode

Figure 29: Linking procedure for FUTABA receiver and transmitter from datasheet

3.6.2. Selecting the airplane type on the FUTABA transmitter

Selecting the airplane type on the FUTABA transmitter	
Step	Task
1	<p>On the FUTABA transmitter, select Linkage menu</p>  <p><i>Figure 30: Selecting Linkage</i></p>
2	<p>Select Model type</p>  <p><i>Figure 31: Select Model type</i></p>
3	<p>Under Model type, verify that the selection is airplane. If this is not the case, select the plane option by referring to step 4. Else, select the wing option and refer to step 5.</p>



Figure 32: Airplane Model

4 Select the airplane under Model type selection

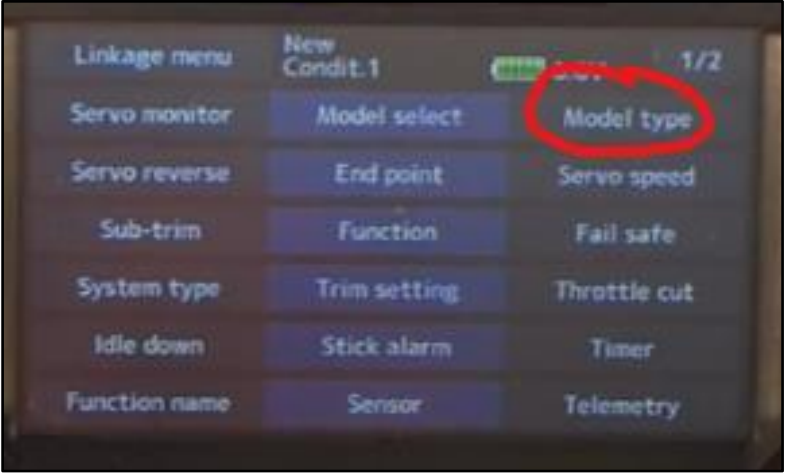

Figure 33: Airplane Selection

5 Select the first option with only 1 aileron channel for both wings. This is to ensure that the Pulse Width Modulation (PWM) signal is balanced for both sides.

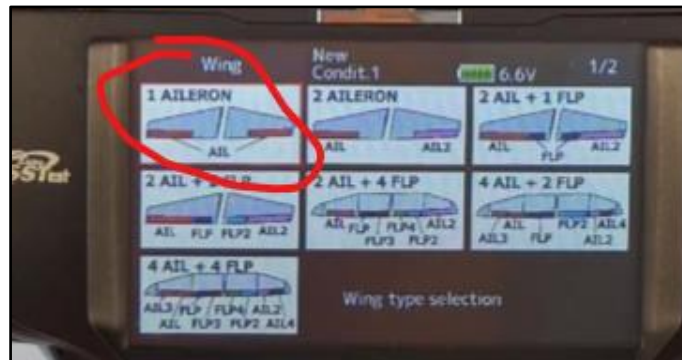

Figure 34: Aileron Selection

6 If all previous steps are completed, the airplane type will be successfully on the transmitter. The rudder selection is ignored as our model does not require the use of a rudder.

3.6.3. Channel mapping on the FUTABA transmitter

To program the functions for the transmitter channel



To program the functions for the transmitter channel	
Step	Task
1	<p>On the FUTABA transmitter, select Linkage menu</p>  <p><i>Figure 35: Linkage Menu</i></p>
2	<p>Select Function</p>  <p><i>Figure 36: Select Function</i></p>
3	<p>Under function, we can map the functions to the respective channel and controls</p>  <p><i>Figure 37: Mapping of functions to channels and controls 1</i></p>



Figure 38: Mapping of functions to channels and controls 2

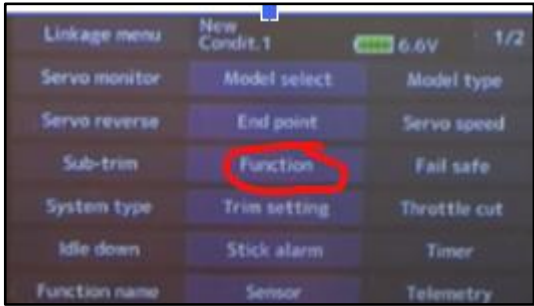

Figure 39: Mapping of functions to channels and controls 3

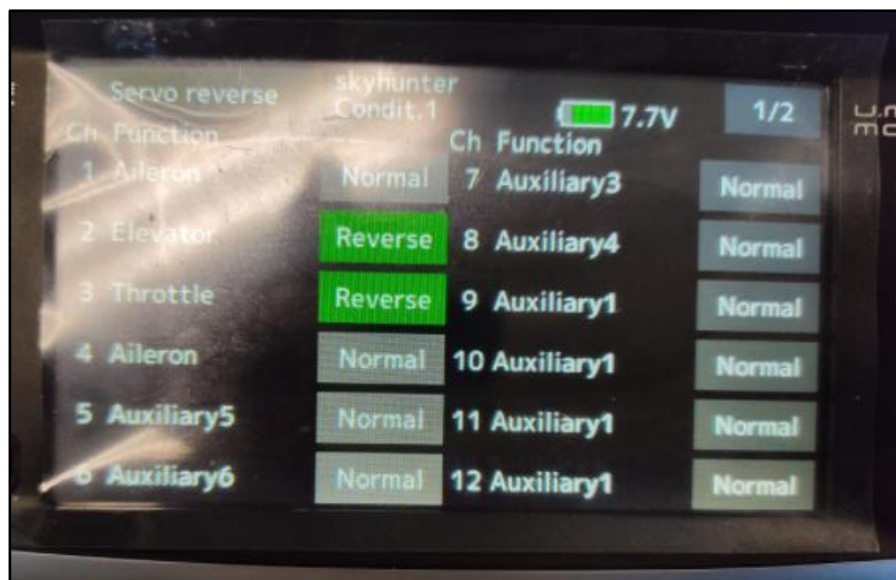

Figure 40: Mapping of functions to channels and controls 4

Channel	Function	Control	Trim
1	Right Aileron	J1	T1
2	Elevator	J2	T2
3	Throttle	J3	T3
4	Left Aileron	J1	T1
5	Aux function 5 (Arm/disarm)	SD	-
6	Aux function 6 (Sensitivity for servo)	SG	-
7	Aux function 3	SE	-
8	Aux function 4 (Flight control mode)	SA	SE

Table 6: Channel Mapping

4. ArduPilot Configuration and Calibration

To begin calibration, first ensure that the Pixhawk 4 is connected to all its peripherals to Mission planner.

4.1. GPS Fix Test

In Mission planner, the GPS should display a 3D fix status (on the bottom right of the cockpit HUD) after successful connection to Mission planner. Occasionally, the reading might display no fix, and this might occur because the GPS is indoors. To display a 3D fix status, simply test this connection outdoors.



Figure 41: 3D fix status on HUD

4.2. Accelerometer Calibration



Figure 42: Accelerometer calibration page

Under Accelerometer Calibration, select the Calibrate Accel button to begin the 3-axis accel calibration. Mission Planner will prompt you to place the vehicle at each calibration position. Press any key to indicate that the autopilot is in position and proceed to the next orientation. Follow the instructions displayed on Mission planner. There is no available UI on Mission planner for this. For reference, Fig 44 below displays accelerometer calibration on Q Ground Control's UI.

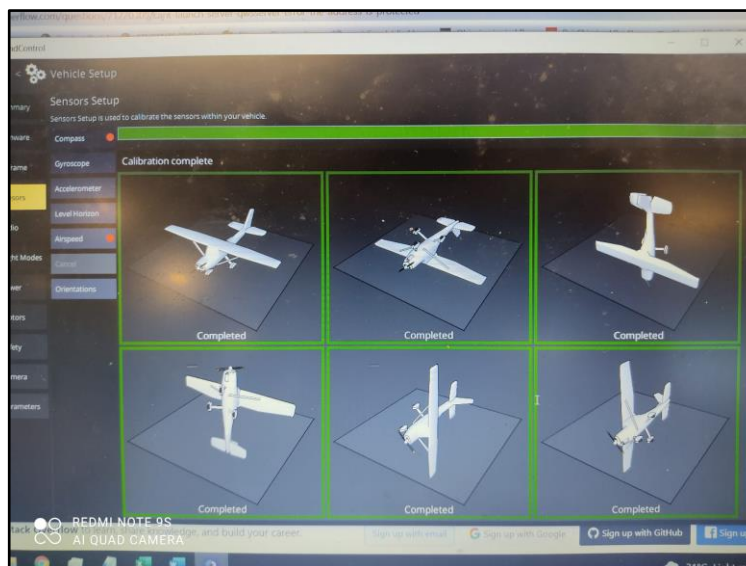

Figure 43: Orientation reference for Acceleration calibration

The calibration positions are level, on right side, left side, nose down, nose up and on its back.

- You may need to calibrate the board before it is mounted to the airplane if the size/shape of the model makes it difficult to orientate the vehicle during calibration

4.3. Compass Calibration

To calibrate the compass on Mission planner, we first select which compass to use. We then mark the priority order and mark them as internal or external.

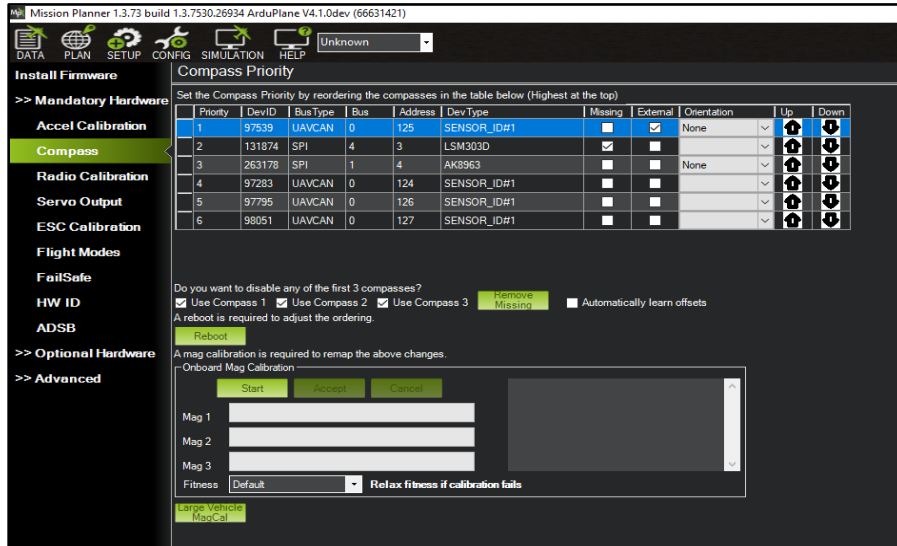

Figure 44: Compass Calibration

It is important that before compass calibration is completed, the vehicle has a 3D GPS lock to assure the best setup. If necessary, move outdoors to get a good 3D GPS lock. For this setup we set the GPS external as priority followed by the Pixhawk 4 compass.

4.4. Radio Calibration

To calibrate the radio, we would need to move transmitter controls to their maximum and minimum values to allow mission planner to capture their PWM values. Follow the steps prompted by the Mission planner after selecting Radio Calibration button.

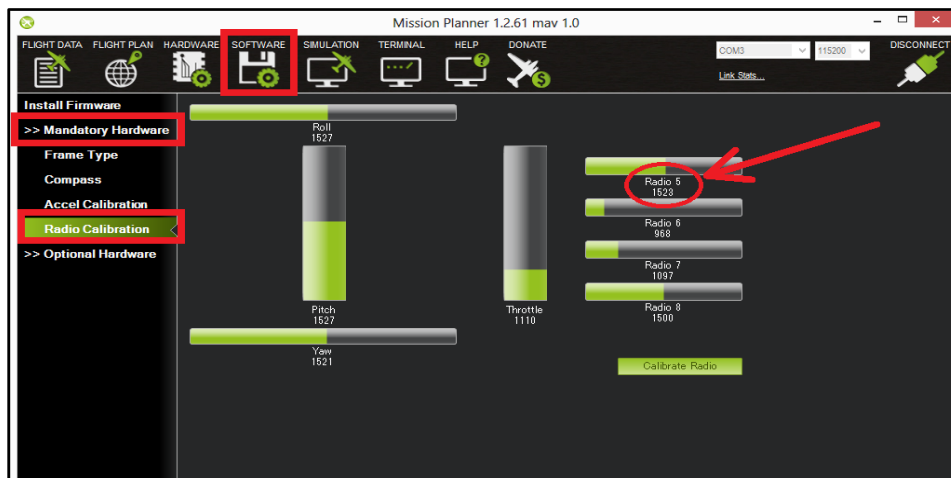

Figure 45: Radio Calibration

4.5. ESC Calibration

The ESC must be manually calibrated as the Mission planner only provides ESC calibration for Arducopter and not Arduplane.

The steps for manual calibration are displayed below in the datasheet:

Connections <<<<

1. Connect the three motor wires to the wires attached to the motor; if the motor rotates in the wrong direction, swap over any two wires.
2. Connect the receiver lead to the throttle socket at the receiver.
3. When the Roxy BL-Control 7xx BEC is connected to the battery, it emits an audible signal according to the set battery type (LiPo battery: 2 x or 3 x beep, depending on cell count. If connected to a NC or NiMH pack, you will hear a melody instead of the beeps).

Programming the Stop / Full throttle position <<<<

1. To program the full-throttle position, switch the transmitter on and pull the throttle stick upwards.
2. Connect the controller to the battery and wait for about two seconds (power-on melody followed by beep sequence for cell count).
3. The unit emits a long beep: this means that the full-throttle position has been detected.
4. Move the throttle stick down and wait about one second: the unit emits a melody. The Stop position is now set.
5. If no confirmation signal is emitted, check that the receiver is working; alternatively operate servo reverse for the throttle channel.
6. Move the throttle stick from the Stop position in the direction of full-throttle: the motor now starts running.

Figure 46: Programming the throttle stick for transmitter

If calibrated correctly, after the device is armed the throttle value should begin when the transmitter joystick is moved from its lowest point.

4.6. Servo Motor Output

Under the servo output tab, we would need to input the functions for each channel and the minimum, trim and maximum values. The picture displayed below is servo output.





#	Position	Reverse	Function	Min	Trim	Max
1	 1500	<input checked="" type="checkbox"/>	Aileron	800	1500	2200
2	 1500	<input type="checkbox"/>	Elevator	800	1500	2200
3	 1000	<input type="checkbox"/>	Throttle	1000	1000	2000
4	 1500	<input checked="" type="checkbox"/>	Aileron	800	1500	2200

Figure 47: Servo Motor Output

4.7. Flight Modes

To configure the flight modes, we would have to first set the channel to control the different flight modes. This is done through the **FLTMODE_CH** parameter in the parameter list under the config tab and for our use case we would have set it to channel 8.

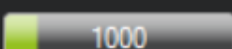
FLTMODE_CH	8	1 16	RC Channel to use for flight mode control
		0-Manual	

Figure 48: FLTMODE_CH parameter

Following this selection, under the config tab, select flight modes and set the parameters as displayed in the Figure 50 below for configuration. The page will display the current mode that the drone is in and the channel (Current PWM) which it is using. As seen in Figure 50 below, the channel is 8 and the PWM value is 0.

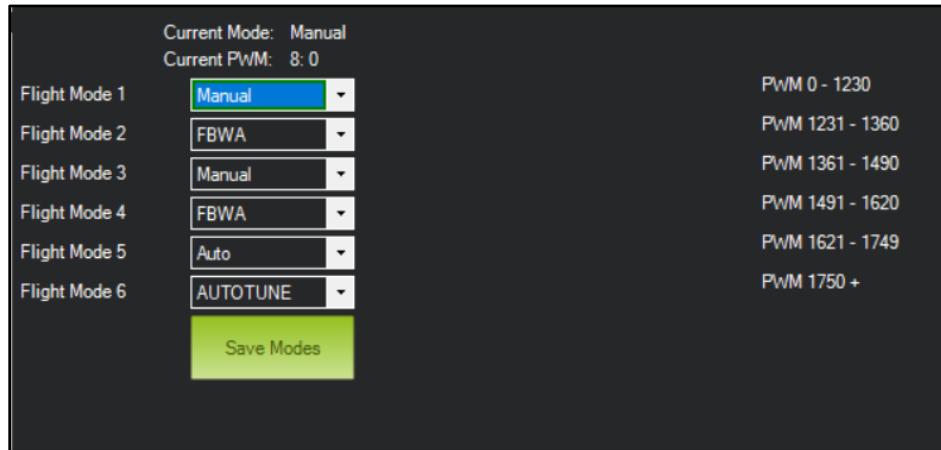

Figure 49: Flight Mode Configuration

4.8. Battery Monitor

To enable battery monitoring, we need to configure the battery monitoring option as displayed in Figure 50 below.

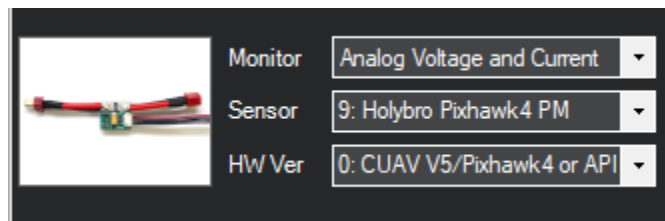

Figure 50: Battery Monitor

4.9. Arm and Disarm Switch

To set our arm and disarm switch, set the RC for it to work on channel 5. Configure the ArduPilot variable RC5_option and write 153 (ArmDisarm for 4.2 and higher). This enables our transmitter to arm and disarm via channel 5.

RC5_OPTION	153	0:Do Nothing 4:ModeRTL 9:Camera Trigger 11:Fence 16:ModeAuto 22:Parachute Release 24:Auto Mission Reset 27:Retract Mount 28:Relay On/Off 29:Landing Gear 30:Lost Plane Sound 31:Motor Emergency Stop 34:Relay2 On/Off 35:Relay3 On/Off 36:Relay4 On/Off 38:ADSB Avoidance En 41:ArmDisarm (4.1 and lower) 43:InvertedFlight 46:RC Override Enable 51:ModeManual 52:ModeACRO 55:ModeGuided 56:ModeLoiter 58:Clear Waypoints 62:Compass Learn 64:Reverse Throttle 65:GPS Disable 66:Relay5 On/Off 67:Relay6 On/Off 72:ModeCircle 77:ModeTakeoff 78:RunCam Control 79:RunCam OSD Control 81:Disarm 82:QAssist 3pos 84:Air Mode 85:Generator 86:Non Auto Terrain Follow Disable 87:Crow Select 88:Soaring Enable 89:Landing Flare 90:EKF Pos Source 91:Airspeed Ratio Calibration 92:FBWA 94:VTX Power 95:FBWA taildragger takeoff mode 96:trigger re-reading of mode switch 98:ModeTraining 100:KillIMU1 101:KillIMU2 102:Camera Mode Toggle 105:GPS Disable Yaw 106:Disable Airspeed Use 107:EnableFixedWingAutotune 108:ModeQRTL 150:CRUISE 153:ArmDisarm (4.2 and higher) 154:ArmDisarm with Quadplane AirMode (4.2 and higher) 155:set roll pitch and yaw trim to current servo and RC 157:Force FS Action to FBWA 158:Optiflow Calibration 160:Weathervane Enable 208:Flap 209:Forward Throttle 300:Scripting1 301:Scripting2 302:Scripting3 303:Scripting4 304:Scripting5 305:Scripting6 306:Scripting7 307:Scripting8
------------	-----	---

Figure 51: RC5_OPTION variable

4.10. SD Card for Logging Flight Data

To obtain flight logs, we would require using a SD card to store data during flight. By default, the mission planner logs all the necessary data that can be analysed. If there is ever a need to filter or add additional log data, do head over the ArduPilot website to check on the various parameters under the logs section in their Docs. Do ensure that the SD card is inserted into the Pixhawk 4. This allows us to obtain flight data which can be useful even in an event of a crash.

5. Integration

Following successful mechanical, electrical and program configuration setup, we can begin integration.

5.1. Integration Assembly

We can ease the process of assembly by attaching all components to a PVC board that is easily attachable to the drone fuselage. To fit this assembly, please follow the steps below.

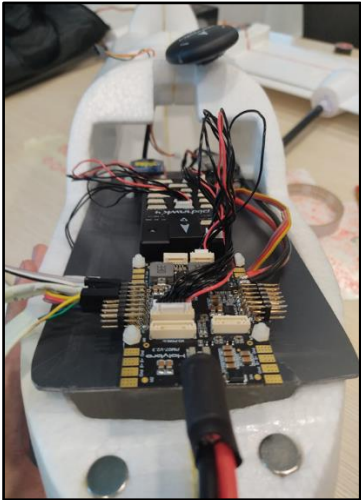
Integration Assembly	
Step	Task
1	<p>Insert the PVC board by aligning it with the bottom section the fuselage. There are several grooves in place to ensure a snug fit. Insert the GPS module wires and RC wires through the top hole. Ensure that the servo wires are facing inwards to as this makes it easier to connect them later.</p>
2	<p>Connect the GPS module and RC wires to the Pixhawk 4 from the front.</p>  <p><i>Figure 52: Insertion of PVC board into the fuselage</i></p>

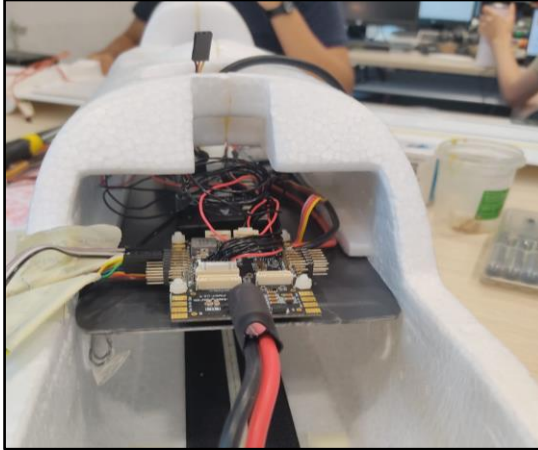

Figure 53: Pushing the PVC into the fuselage

Continue to slide the board backwards through the grooves and connect the servo wires from the wing to the Pixhawk 4. This is done through the wing opening. At this point of time, the wing should be positioned near the wing opening and properly aligned.

3

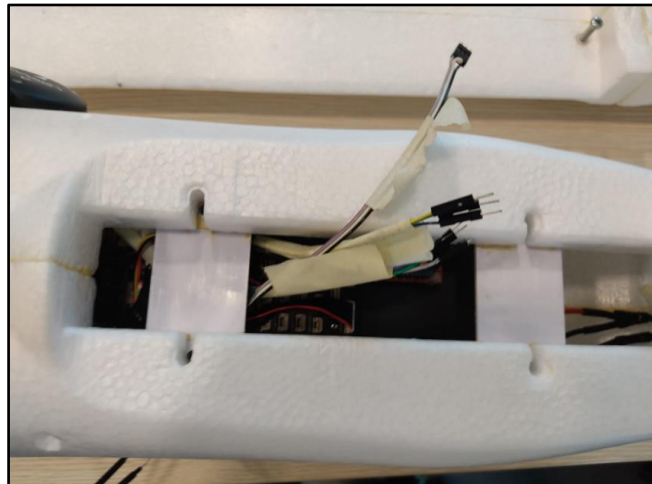

Figure 54: Top View of the fuselage

4

After connecting the servo wires, slide the PVC all the way back to the end of the groove. Following this, we can connect the motor wires from the rear hole.

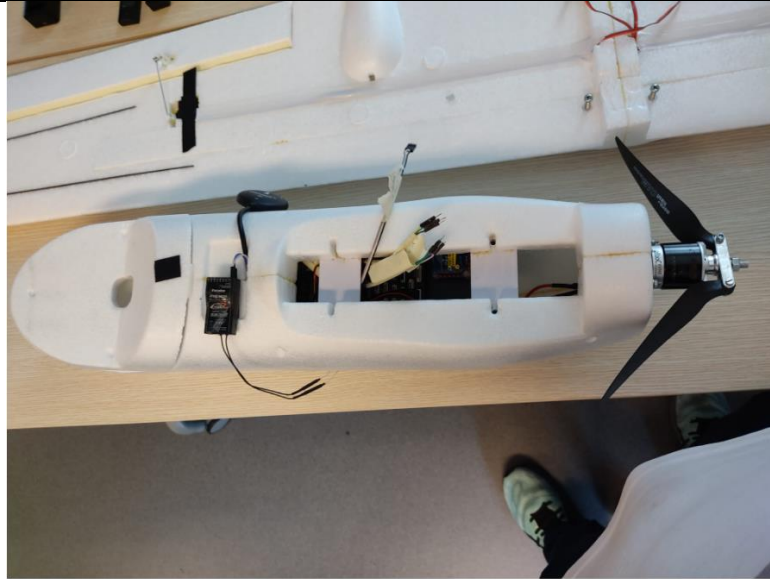

Figure 55: PVC slid back to the edge

<p>5</p>	<p>After everything has been connected, position the battery at its demarcated area and connect it to the PM07 connection. This immediately powers up the system. The ESC should begin emitting a beeping sound and this is followed by a beeping sound from the GPS. The RC receiver should have a red LED output (as the transmitter is off).</p>
<p>6</p>	<p>We can then switch on our transmitter to check if the servos are functioning after assembly. The motor should not be armed but as a precaution, adjust the throttle to its minimum position.</p>
<p>7</p>	<p>If all components are functional, we can secure the wing to the fuselage by screwing it in.</p>

5.2. Finding Center of Gravity (CG) of RC Aircraft



Figure 56: Side View of CG testing with 2 points on the wing



Figure 57: Rear View of CG testing with 2 points on the wing

The CG of the aircraft refers to the Center of Gravity of the fixed wing drone which in this case, is the Skyhunter model that we chose to work with. This process is important as the Center of Gravity is important to balance the fixed wing drone during flight control operations especially since the Skyhunter is a nose-heavy plane due to its design.

The instruction manual provides us with a range where the CG is marked on the aircraft in terms of distance from the leading edge of its wing. This allows us to adjust the components forwards and backwards and continuously conduct a balancing test on the marked point to ensure that the fixed wing drone maintains its flight characteristics during operation.

The balancing test is a finger balancing test conducted on the marked points provided by the instruction manual. These points are maintained as we slot the components in respective places that ensure the fixed wing drone is level when it's balanced on the fingers once more.

Once the components are placed in their respective places and the fixed wing drone is still balanced, we will mark their positions so that if there is a need for removal of the components, we are able to place them back at their respective places when any rectification is required. This eliminates the need to constantly check the CG of the aircraft.

5.3. Integration Test

Components required:

- 1) Mission planner program
- 2) Radio Control
- 3) Proper wiring and connections of all electronic components
- 4) Telemetry module
- 5) Assembly of all physical components without propeller
- 6) SD card for collecting flight data before flying inserted into Pixhawk 4

Initial integration test is a functional test with all components connected.

Initial Test	
Step	Task
1	Start-up Mission Planner and connect the Pixhawk 4 via USB. Connect the battery to the PM07 power distribution board. (DO NOT ARM). Switch on Futaba RC transmitter and put throttle stick to minimum position
2	Test for all components that reads on the Mission planner (RC PWM Values, GPS fix, Battery Level, Cockpit HUD responding (manual movement of the fixed wing drone to check if it can detect the level horizon).
3	If everything is functional, arm the drone to begin testing the motor (either via RC switch or Mission planner). Ensure area around propeller is clear before spinning
4	After testing the motor, disarm. Now move the pitch and roll stick on the RC to ensure ailerons are behaving correctly. Leave the battery connected
5	Disconnect the USB from the Pixhawk 4 and now connect the Pixhawk 4 via Telemetry using the Xbee on the laptop

6	Repeat steps 2,4, ensure mission planner is reading
7	On the RC, Activate the flight mode FWBA, Mission planner should reflect FWBA mode as well
8	Tilt the drone back(elevate), the rear aileron should compensate and try to descend Tilt the drone front(descend), the rear ailerons should compensate and try to elevate
9	Tilt the drone left, the drone should compensate and try to move right Tilt the drone right, the drone should compensate and try to move left
10	Now, check the mission and attempt to review the Data flash log and telemetry log that is automatically generated when the vehicle was armed.
11	If everything is in order, we have completed the initial integration test

6. Operations

6.1. RC Operation (Manual)

6.1.1. Rolling

The SonicModell Skyhunter fixed wing drone is only capable of rolling and pitching due to its rudderless design. When rolling to the right, the right aileron is up, and the left aileron is down. The RC controller has already been calibrated to roll right by toggling the **right** toggle stick to the **right**.

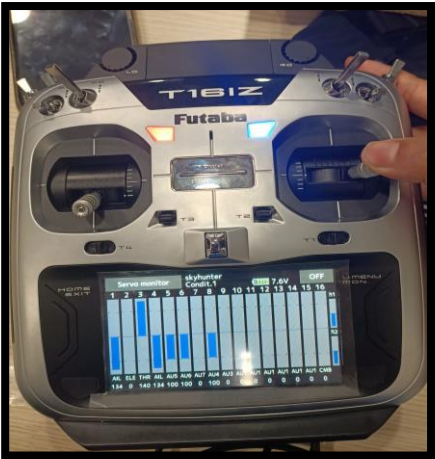
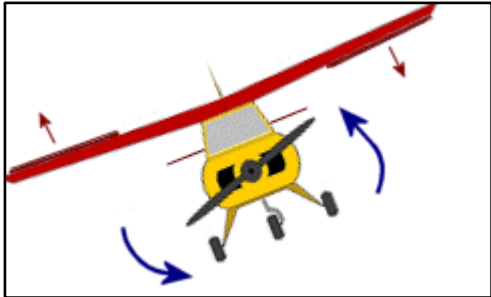
Roll Right	
Toggle	Function
 <p><i>Figure 58: Toggle the right toggle stick to the right</i></p>	 <p><i>Figure 59: To roll drone to the right</i></p>

To roll left, toggle the **right** toggle stick to the **left**.

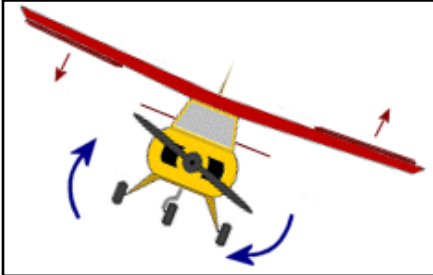
Roll Left	
Toggle	Function
 <p><i>Figure 60: Toggle the right toggle stick to the left</i></p>	 <p><i>Figure 61: To roll drone to the left</i></p>

6.1.2. Throttling



It is **always safe practice to toggle the throttle stick downwards prior to switching on the system.** The throttle is extremely sensitive. To throttle forward, throttle the toggle stick upwards. To access the full capabilities of the motor, throttle the left toggle stick upwards gradually. (Do not throttle it abruptly - this might damage the motor). At this point in the Figure 62 below, the mid throttle is already activated.



Figure 62: Minimum Throttle activated

6.1.3. Pitching

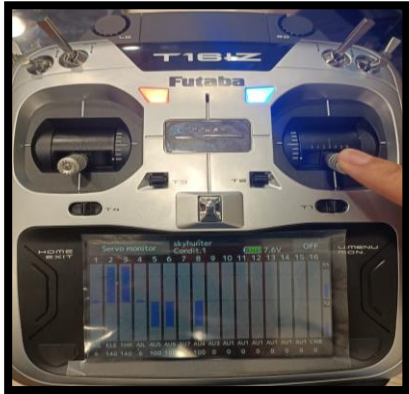
A pitch motion is an up or down movement of the nose of the aircraft. To pitch downwards in descent, move the **right** toggle stick **downwards**. **Note, that pitch may be set inverted for ease of use of other users. To revert, do so in the transmitter's setting under servo reverse. Do check this before flying**

Pitch Downwards	
Toggle	Function
 <p><i>Figure 63: Toggle the right toggle stick down</i></p>	 <p><i>Figure 64: To pitch downwards</i></p>

To pitch upwards for the aircraft to climb, throttle the **right** toggle stick **upwards**.

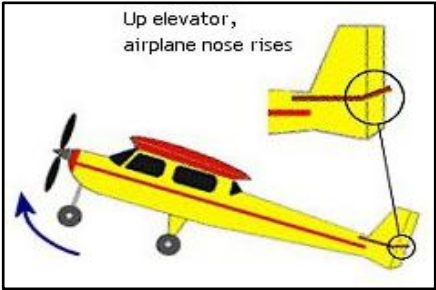
Pitch Upwards	
Toggle	Function
 <p><i>Figure 65: Toggle the right toggle stick up</i></p>	 <p><i>Figure 66: To pitch upwards</i></p>

Controls		
RC	Left Toggle	Right Toggle
Stationary	Toggle Down	Neutral
Throttle (Right Movement)	Toggle Upwards (Gradually Increase)	Neutral
Roll Right (During Flight)	Throttle Upwards	Toggle Right
Roll Left (During Flight)	Throttle Upwards	Toggle Left
Pitch Upwards (Climb)	Throttle Upwards	Toggle Down
Pitch Downwards (Descent)	Throttle Upwards	Toggle Up

Table 7: List of Controls

6.1.4. Additional features

Arm and Disarm Toggle Switch	
Toggle	Function
	<p>Arm and Disarm function under SD switch, Neutral nothing Toggle Up – Disarm Toggle down - Arm</p>

Figure 67: Arm and Disarm Toggle Switch

Flight Mode Toggle Switch	
Toggle	Function
	<p>Flight mode toggle switch by SA and SE SE neutral, SA toggle up – Manual SE neutral, SA neutral – FWBA SE neutral, SA toggle up – Autotune SE up, SA toggle neutral – Auto mode</p>

Figure 68: Flight Mode Toggle Switch

6.2. Autonomous Operation

For autonomous operations, follow the steps listed below:

Autonomous Operation																																																													
Step	Task																																																												
1	<p>Plan the route/mission on the Mission Planner software. Once route is planned, write the mission to the drone either via USB or telemetry radio.</p>  <p>The screenshot shows the ArduPilot Mission Planner interface. At the top, there are menu options: DATA, PLAN, SETUP, CONFIG, SIMULATION, and HELP. The main area displays a satellite map with a yellow mission path consisting of several waypoints. A table at the bottom lists the mission parameters:</p> <table border="1"> <thead> <tr> <th></th> <th>Command</th> <th>Delay</th> <th></th> <th></th> <th>Lat</th> <th>Long</th> <th>Alt</th> <th>Frame</th> <th>Delete</th> <th></th> <th>Grad</th> <th>Angle</th> <th>Dist</th> <th>AZ</th> </tr> </thead> <tbody> <tr> <td>1</td> <td>WAYPOINT</td> <td>0</td> <td>0</td> <td>0</td> <td>1.2335063</td> <td>103.67748...</td> <td>100</td> <td>Relative</td> <td>X</td> <td></td> <td>25.4</td> <td>14.2</td> <td>406.4</td> <td>317</td> </tr> <tr> <td>2</td> <td>WAYPOINT</td> <td>0</td> <td>0</td> <td>0</td> <td>1.2346647</td> <td>103.67984...</td> <td>100</td> <td>Relative</td> <td>X</td> <td></td> <td>0.0</td> <td>0.0</td> <td>292.3</td> <td>64</td> </tr> <tr> <td>3</td> <td>WAYPOINT</td> <td>0</td> <td>0</td> <td>0</td> <td>1.2336135</td> <td>103.68147...</td> <td>100</td> <td>Relative</td> <td>X</td> <td></td> <td>0.0</td> <td>0.0</td> <td>215.7</td> <td>123</td> </tr> </tbody> </table>		Command	Delay			Lat	Long	Alt	Frame	Delete		Grad	Angle	Dist	AZ	1	WAYPOINT	0	0	0	1.2335063	103.67748...	100	Relative	X		25.4	14.2	406.4	317	2	WAYPOINT	0	0	0	1.2346647	103.67984...	100	Relative	X		0.0	0.0	292.3	64	3	WAYPOINT	0	0	0	1.2336135	103.68147...	100	Relative	X		0.0	0.0	215.7	123
	Command	Delay			Lat	Long	Alt	Frame	Delete		Grad	Angle	Dist	AZ																																															
1	WAYPOINT	0	0	0	1.2335063	103.67748...	100	Relative	X		25.4	14.2	406.4	317																																															
2	WAYPOINT	0	0	0	1.2346647	103.67984...	100	Relative	X		0.0	0.0	292.3	64																																															
3	WAYPOINT	0	0	0	1.2336135	103.68147...	100	Relative	X		0.0	0.0	215.7	123																																															
2	Set the fixed wing drone to Manual mode and take-off manually																																																												
3	Once in the air, switch its setting to auto mode.																																																												
4	Drone will execute its mission and loiter around the landing area.																																																												
5	Switch the setting to manual mode to land the fixed wing drone.																																																												

Figure 69: Autonomous planning on Mission Planner

7. Testing Procedure

7.1. Prior to flight

Figure 70 shows the RC and Telemetry Range Testing on Site procedure



Range Testing Your R/C System

It is extremely important to range check your models prior to each flying session. This enables you to ensure that everything is functioning as it should and to obtain maximum enjoyment from your time flying. The T16SZ transmitter incorporates a system that reduces its power output and allows you to perform such a range check.

Range check mode

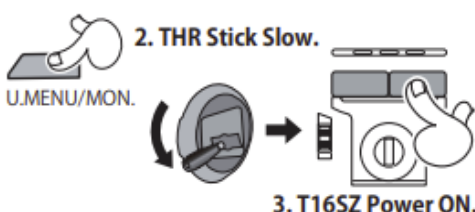
- While pushing "U.MENU/MON." button.
- THR Stick Slow.
- T16SZ Power ON.
- Select "Range check" at the System menu.

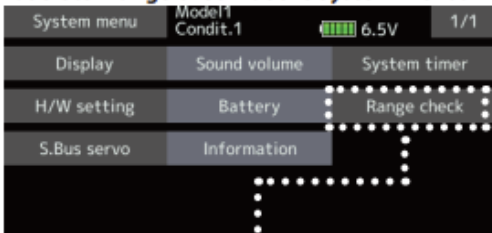

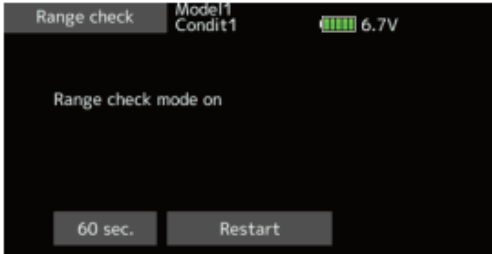
During this mode, the RF power output is reduced so the range test can be performed. In addition, when this mode is activated the right LED on the front of the transmitter starts blinking and the transmitter gives users a warning with a beeping sound.

The "Range check mode" continues for 60 seconds and after that the power will return to the normal level. To exit the "Range check mode" before the 60 seconds, press the "HOME/EXIT" button. NEVER start flying when the "Range check mode" is active.

Should you require additional time to perform a range check, highlight Restart before your time expires and tap the screen one time.

Range check procedure

- With the "Range check mode" on, walk away from the model while simultaneously operating the controls. Have an assistant stand by the model to confirm that all controls are completely and correctly operational. You should be able to walk approximately 30-50 paces from the model without losing control.
- If everything operates correctly, return to the model. Set the transmitter in a safe, yet accessible, location so it will be within reach after starting the engine or motor. Be certain the throttle stick is in the low throttle position, then start the engine or motor. Perform another range check with your assistant holding the aircraft with the engine running at various speeds. If the servos jitter or move inadvertently, there may be a problem. We would strongly suggest you do not fly until the source of the difficulty has been determined. Look for loose servo connections or binding pushrods. Also, be certain that the battery has been fully charged.

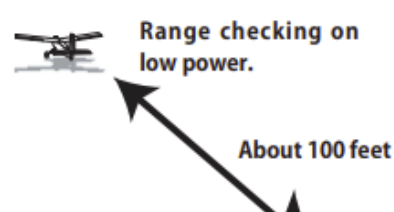

Figure 70: Futaba Datasheet on RC and telemetry range testing

7.1.1. Safety and Risk Checklist

As a measure to ensure that flight operations are safe for both the operator and the bystanders nearby, we created a checklist which is to be conducted prior to every flight test. This safety checklist covers three distinct categories which is initial component check, processes before and after arming as well as risk and mitigation measures that should be followed prior to the conduct of every flight.

These checklists are to be followed accordingly and no flight operation should be conducted if any of the conditions listed in this checklist is not fulfilled. This is to ensure that if any unfavourable situation occurred, it would minimise the damage that would be experienced by the aircraft or injuries to users and bystanders nearby.

Risk mitigation sections in the checklist are not conditions that can be fulfilled in the checklist but rather measures to advise the user and operators that would help ensure they operate the drone within the law and minimise damage to the drone as well as users and bystanders should an accident occur. The mitigation measures are listed at the bottom section of the safety checklist.

SAFETY CHECKLIST				
COMPONENT CHECK			Y	N
Propellers	Are the propellers bent or broken?			
	Does the propeller display any signs of stress marks?			
	Is the visible damage extensive?			
Motor Shaft	Is the motor shaft bent or broken?			
	Is the visible damage extensive?			
Motor	Is there dirt or unfamiliar materials in the motor?			
	Is the motor difficult to rotate manually?			
Servos	Is it difficult to move by hand?			
	Are the linkages to the control surface damaged?			
Fuselage	Is there visible damage on the control surface of the drone?			
	Are the attachments secure?			
	Are there any damages on any ailerons or flaps?			
	Do servo attachments fully rotate/extend?			
Battery	Are there any visible dents/damage to the battery?			
	Is there any battery leakage?			
If any of the answers above is No, please resolve immediately with replacement/rectification				
BEFORE ARMING				
1	Verify if all components are wired correctly			
2	Verify if battery is sufficiently charged			
3	Verify if RC transmitter is sufficiently charged			
4	Verify connection with mission planner telemetry			
5	Verify signal strength for telemetry and for radio connectivity			
6	Verify GPS signal			
7	Ensure ESC is calibrated			
8	Ensure Ailerons/Servos/Elevators function as intended			
9	Verify readings on mission planner are accurate			
10	Check for any signal failure in mission planner			
11	Verify functionality of RC auxiliary channels			
12	Check if RC transmitted PWM values are translated to mission planner			
SAFETY CHECKS BEFORE FLIGHT				
1	Stay clear of propeller prior to armament			
2	Ensure area is clear			
3	Ensure location for flight is a no-fly zone			
4	Ensure all components are secured			
5	Check for potential hazards to drone flight			
6	Ensure emergency cutoff is working as intended			
7	Ensure operator is at a level and a path where we are able to visibly see the drone			
8	Ensure radio transmission at long distances are functional			
RISK MITIGATION PRIOR TO AND DURING FLIGHT				
<ul style="list-style-type: none"> • As best we can, try to find an empty plot of land within fly zone where there are no others nearby • In the event of bad weather, manual override and land immediately • Check weather forecast prior to date of flight for chance of bad weather and lightning • Ensure that we test manual capabilities and ensure that they work sufficiently well before moving on to autonomous capabilities • Prior to full autonomous flight ensure that we are able to override with manual flight controls • Ensure long range communication with drone possible before even flying by testing whether drone will be able to receive signals from a very far distance prior to flight • Ensure pilot has full familiarity with drone controls before attempting flight • Ensure we have the necessary safety equipment in the event of battery fire mid flight (we noticed that this might be a possibility from online videos that we saw although its very unlikely). Our plan is to bring a fire extinguisher and gloves just in case of such an event. • Ensure that we fly at a level and a path where we are able to visibly see the drone • In the event of an imminent crash (where we have manual control over the drone) <ul style="list-style-type: none"> o Direct the drone to an area where there is safe to crash land (no fliers, free space) o Shut throttle off immediately to prevent and avoid ESC damage (if possible calibrate emergency kill switch and ensure its working) 				

Figure 71: Safety Checklist

7.1.2. Route Planning (Holland)

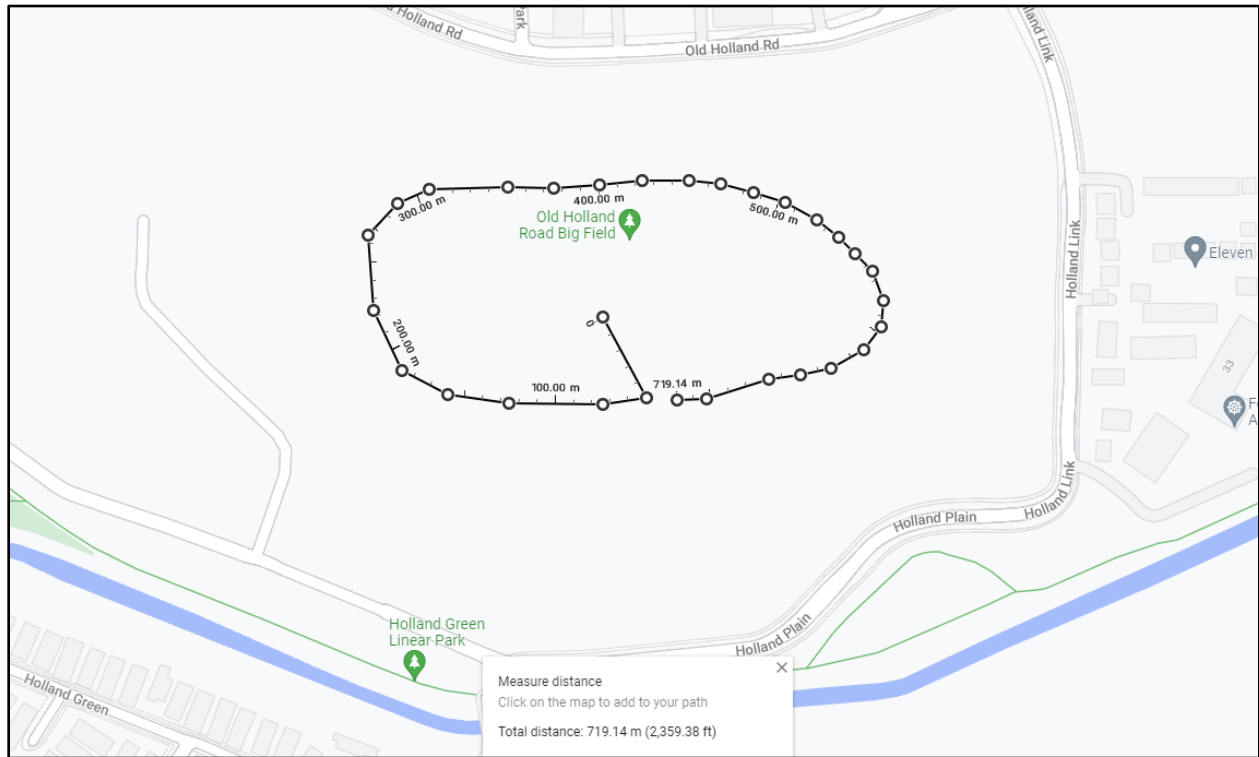

Figure 72: Old Holland Road Route

Figure 72 shows the route planning which was used to test the fixed wing drone manually prior to doing an autonomous operation. The route was planned to ensure that the drone would fly at a safe distance from the drainage/canals, roads, and buildings. This is to ensure that in an event of a crash, the fixed wing drone would be retrievable.

The route that was planned at Old Holland Big Field, which is a testing area that caters to all our needs and is used as our main testing area for all our test procedures.

7.2. During Flight

7.2.1. Take-off Method: Hand Launch



Figure 73: Hand Throwing take-off

For the fixed wing drone to take-off, it must be hand thrown due to it not having landing gears for it to do a horizontal take-off and landing. Figure 73 shows an example of the hand thrown take-off method [4]. Figure 74 below shows the hand thrown take-off method which we attempted when flying our fixed wing drone manually.



Figure 74: Attempt to hand throw take-off

7.2.2. Metrics

Table 8 below shows the metrics which need to be monitored during flight

RC System	<ul style="list-style-type: none">• Battery level of Transmitter• Range and connectivity of RC
Mission Planner	<ul style="list-style-type: none">• Battery level of fixed wing drone• Power consumption• Stability of flight• Response of IMU• GPS accuracy• Speed of fixed wing drone• Altitude of fixed wing drone

Table 8: Metrics monitored during flight

8. Manual Flight Test

A maiden flight was conducted on the 24th of February 2022. This test flight to validate the manual operations of the aircraft and to verify whether it can withstand the forces acting against it during flight. It would be the first form of self-assessment that we would conduct test the manual capabilities of the aircraft.

8.1. Pre-Flight Planning and Prerequisites

In preparation of the manual flight, we had to ensure that several prerequisites were met prior to each test flight. These prerequisites include checks, tools as well as personnel. Some of these prerequisites are listed below

- Calibration tests are completed
- An autonomous bench test is completed
 - This test is conducted prior to all flights with autonomous operations
- An experienced drone pilot
- Availability of a suitable and legal testing area
 - Suitable weather conditions
- All conditions in safety checklist are met



Figure 75: Conducting of pre-flight checks

8.2. Data Collation from Manual Flight Test

To analyse data that we can generate from our flight with the ArduPilot software we can utilize log viewers online for ArduPilot data flash and telemetry logs. Data here can be easily plotted and the flight will be visually re-flown in 3D. There are various viewers on the internet but the one that

we utilize for our flights is the **UAV Log Viewer** which is web based, although most computations are done locally in the web browser. Both Chrome and FireFox are supported browsers [5].

Below is a snippet of the interface of UAV Log Viewer. As seen in the column on the left, there are multiple options to view different types of data from the flight logs that was uploaded. These include data of the ailerons, throttles to data from servo channel outputs.



Figure 76: Snippet of UAV Log Viewer

Below are some snippets of the data that we have generated and analysed from our maiden flight.

Flight Status (STAT.isFlying)

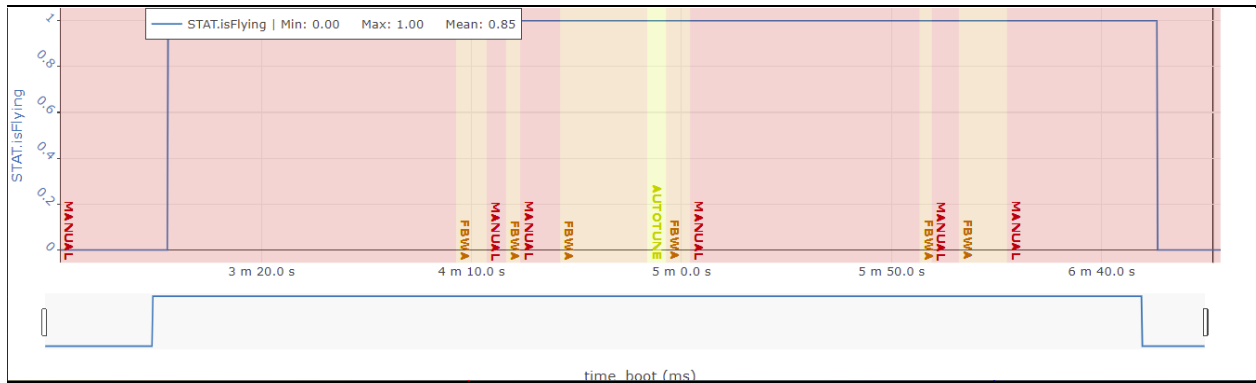

Figure 77: STAT.isFlying vs Time

An example of the data collated is displayed above. This displays the flight status in UAV Log Viewer which depicts the time when the aircraft is most probably flying. This data would be extremely useful for testing autonomous flights in the future testing phases to observe whether we can achieve the 1-hour autonomous operations requirement. As seen in the figure above, we flew only for a duration 3 minutes and 55 seconds. The fixed wing drone began flying at the 2 minute and 58 second mark and landed at 6 minutes and 53 seconds.

It is to be noted that the flight duration from this maiden flight does not reflect the total and optimal usage of the battery as endurance testing is conducted in the later stages.

GroundSpeed (GPS.Spd)

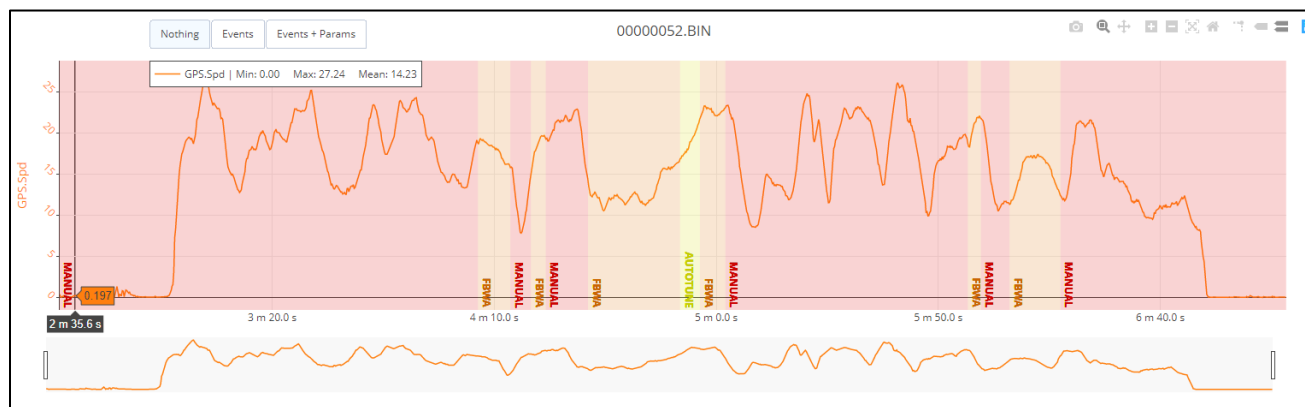

Figure 78: GPS.Spd vs Time

Another sample of data from our maiden flight is displayed here which displays the groundspeed measured from our GPS module which is measured in m/s. As seen in the plot above, we find that our mean groundspeed is measured to be 14.23 m/s which is essentially 51 km/h and our maximum groundspeed is 27.24 m/s which is 98 km/h.

The maximum groundspeed occurs at the earliest stage of the flight which correlates to when the aircraft requires the greatest throttle and groundspeed to be able to generate maximum lift.

Current Drawn and Throttle vs Time (BAT.Curr, AETR.thr)

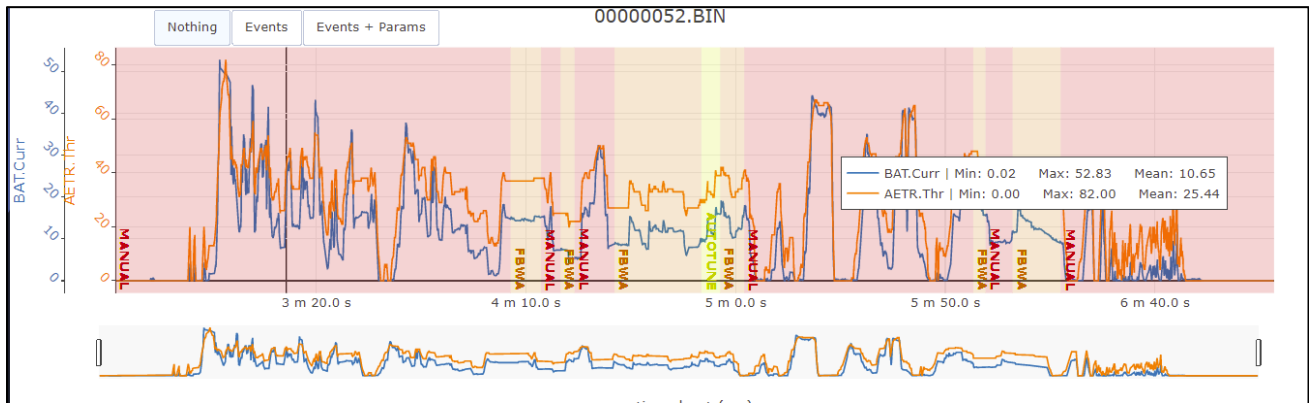

Figure 79: Current Drawn and Throttle vs Time

In addition to plotting all types of data from our flight logs, we can also sample data against one another in the UAV Log Viewer. For example, as seen in the figure above, we can plot both current draw and throttle in the same plot. This displays the correlation between the current draw and the throttle and their proportionality which verifies how the usage of the throttle directly affects the total current draw from the battery. As seen in the plot above, we find that the max throttle during the flight which is only 82% of the total throttle we have a current draw of 52.83A and at mean throttle which is 25.44% of total throttle we have a current draw of 10.65A.

In addition to this, there are other types of data that could be found and analysed from our flight logs. Some of them which pertain to our objective are the ones listed above and the ones that are listed below. These set of data should be utilized and analysed for future testing phases.

Barometer and GPS and Canonical Calculated Altitude vs Time (BARO.Alt, GPS.Alt, POS.Alt)

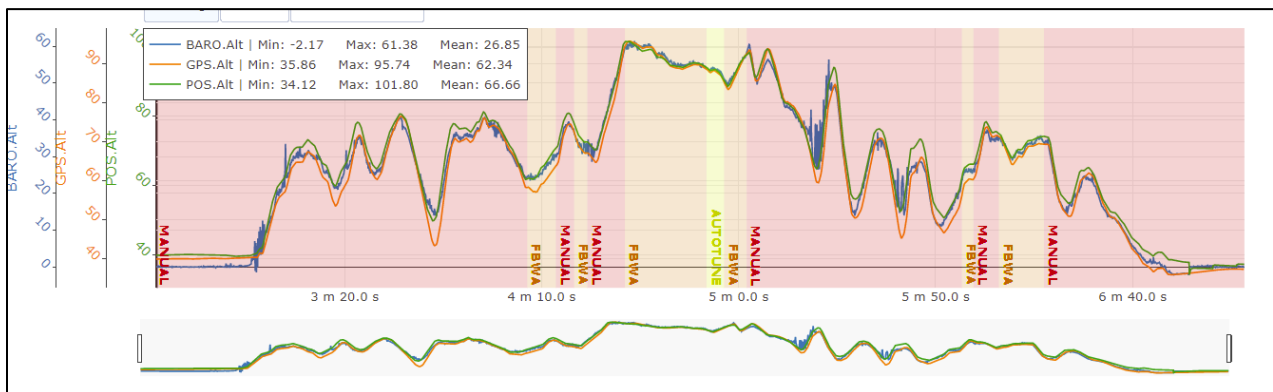

Figure 80: Barometer, GPS, and Canonical Calculated Altitude vs Time

Figure 83: Console Messages

Console messages provide us with information on log messages stored onboard ArduPilot vehicles during operations

8.3. Post Flight Analysis from Manual Flight

On all accounts, the maiden flight was a successful one with the fixed wing drone being able to withstand all forces that were acting against it and at the same time, perform at both low and high throttle effectively.

This performance could be attributed to the design of the model itself which provided for great mobility and stability during a flight. From our observations, we managed to identify areas for improvements that could be worked on prior to our next few flights.

Firstly, we realized that we had underestimated the capabilities of the motor and its expected performance with the overall system. We were partly sceptical of its performance as to the untrained eye it did not seem as if it would essentially provide much power for the fixed wing drone to generate lift. However, upon the first iteration of the testing phase, we found that the motor was highly efficient and that the fixed wing drone moved at incredibly high speeds even with the slightest movement of the throttle. Our expected range of mid throttle flight allowed the drone to move to groundspeeds of up to 70-80km/h. Essentially, this groundspeed was way above our stall speed which was calculated to be 11 m/s or 39.6 km/h. Therefore, we would have to take note of this prior to conducting autonomous flight as we would be able to conserve a large amount of power if we were able to find the optimal speed that our drone could operate at. This would significantly increase the overall battery performance and prolong the duration of our flight to help us get closer to our objective of reaching an hour of autonomous flight time.

Secondly, our post flight inspection found some minor movements of components within the fuselage along with the loosening of reinforced components such as motor mounts. This might have contributed to vibrations that were experienced during the flight which might have affected the stability of the aircraft during the flight. In theory, these vibrations might affect the overall duration of the flight during autonomous operations if the autonomous features begin to compensate and adjust throttle speed and servo movements to ensure stability of the fixed wing drone. These compensations would most likely affect the overall consumption of battery power and result in a shorter duration in flight time.

To address these observations that we noticed from our maiden flight, we conducted several improvements as listed below:

- Reinforce the components using stronger adhesives
- Replace loose wiring and securing their positions using tapes
- Added additional foam platforms that have insignificant weight to stabilise and protect platforms and components within fuselage

- Conducted further simulations to determine optimal groundspeed to prolong battery performance during autonomous flight

9. Autonomous Testing

This section describes the preparation, the autonomous flight test conducted and the data collation from the autonomous flight test.

9.1. Preparation

Following our maiden flight, we planned to begin testing for the autonomous functionality of the fixed wing drone. Several test flights were planned with us striving to achieve different flight durations with us slowly increasing the objective with every test flight.

Test	Flight Duration to Achieve (minutes)
1	20
2	35
3	40
4	60

Table 9: Planned Flight Tests

However, due to severe weather conditions in the early period of 2022, we only managed to conduct one autonomous test out of the four planned. Our test flights had to also fit in conveniently with the schedule of our flight operator as we still required his technical assistance to ensure that he is always readily available should the fixed wing drone require immediate manual toggling during our test flight.

To plan for autonomous flight testing we needed:

- To plan a route
 - Within ArduPilot Mission Planner we can plan a mission with waypoints and events
- Ensure we are familiarized with the test procedure
 - There is different toggling of modes required during the autonomous flight test
- Ensure all peripherals are in good working order
 - Conduct individual component tests prior to every flight
 - Servos
 - Ailerons
- Conduct Autonomous Compensation Test prior to every autonomous flight
 - Autonomous bench testing helps us to verify the autonomous operations during flight

- In this test, we lift the plane in autonomous mode and orientate it in different directions. To stabilise itself, the servos will orientate to roll right or left or pitch upwards and downwards.

9.2. Autonomous Flight Test

Our first and only autonomous flight test was conducted at the Old Holland Big Field. On all accounts it was a successful one which exceeded all expectations that we had prior to the test.

The link to the flight recorded on mission planner is displayed below:

<https://drive.google.com/file/d/1ZyEPsnQdZCpN4noOTpmqP8GjDjpqTgmH/view?usp=sharing>

The link to a snippet of the GOPRO recording of the flight is displayed below:

https://drive.google.com/file/d/1_iAwEDjnZ6-t18sv_Hatflx_YEsHf-7Z/view?usp=sharing

During our autonomous flight test, we managed to successfully fly the fixed wing drone for a total flight time of 34.63 minutes with an average ground speed of 13.65 m/s. For our first attempt, we felt like this heavily exceeded our expectations as we managed to identify multiple areas of improvements that would prolong its flight duration in the future. Some snippets of our autonomous flight are displayed in the images below.



Figure 84: Autonomous Drone Flight



Figure 85: Autonomous Drone Flight with ArduPilot



Figure 86: Autonomous Fixed Wing Drone flying in Old Holland Road Big Field

9.3. Data Collation from Autonomous Flight Test

Using log viewers online we managed to view and analyse the data from our flight through the log files we attained from ArduPilot Mission Planner.

Flight time (GPS Speed)

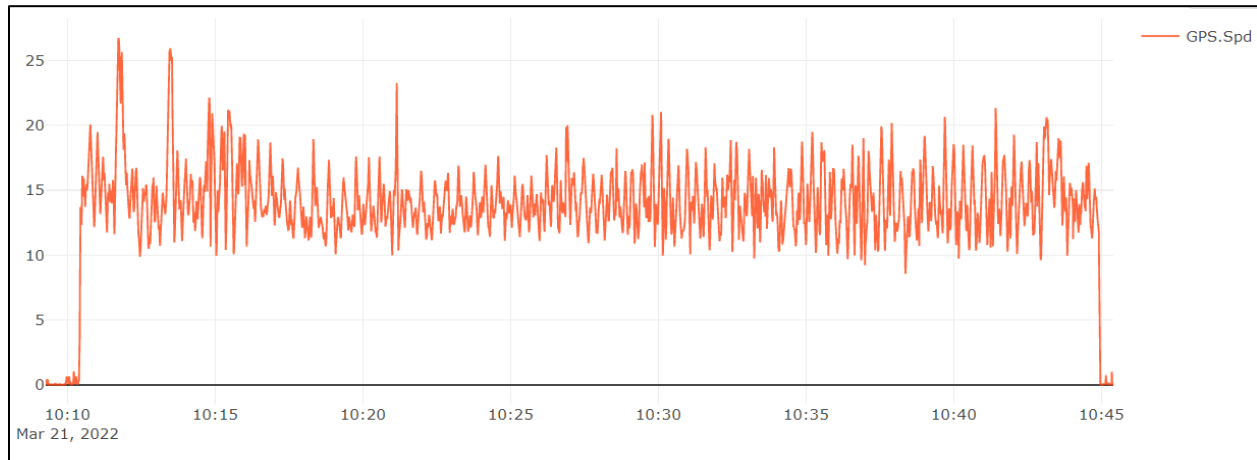

Figure 87: GPS Speed vs Flight Time

From the image above, we can see that the orange plot which represents our total flight time for this flight was 34.63 minutes from 10:10 am to 10:45am. This was measured from our GPS speed module.

Voltage Measurement (BAT.Volt, BAT.VoltR)

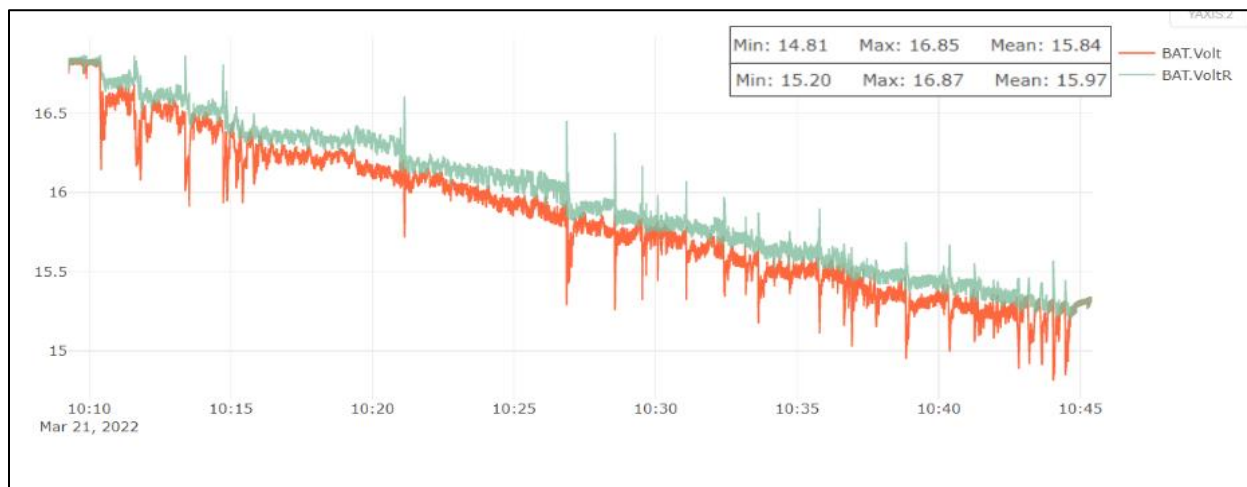

Figure 88: Voltage Measurement vs Time

From the Figure 88 above which displays the plot of our voltage measurement and voltage measurement at rest we can see that at the start of the flight we began with 16.85 V which at rest was at 16.87 volts. The decision to land was made when the voltage measurement at rest was at

15.2 V and the final voltage measurement at the end was 15.33V. It is to be noted that our battery is a 4 cell battery with a maximum charge or 16.8V (4.2V x 4) when fully charged.

Power Consumption in mAh (BAT.CurrTot)

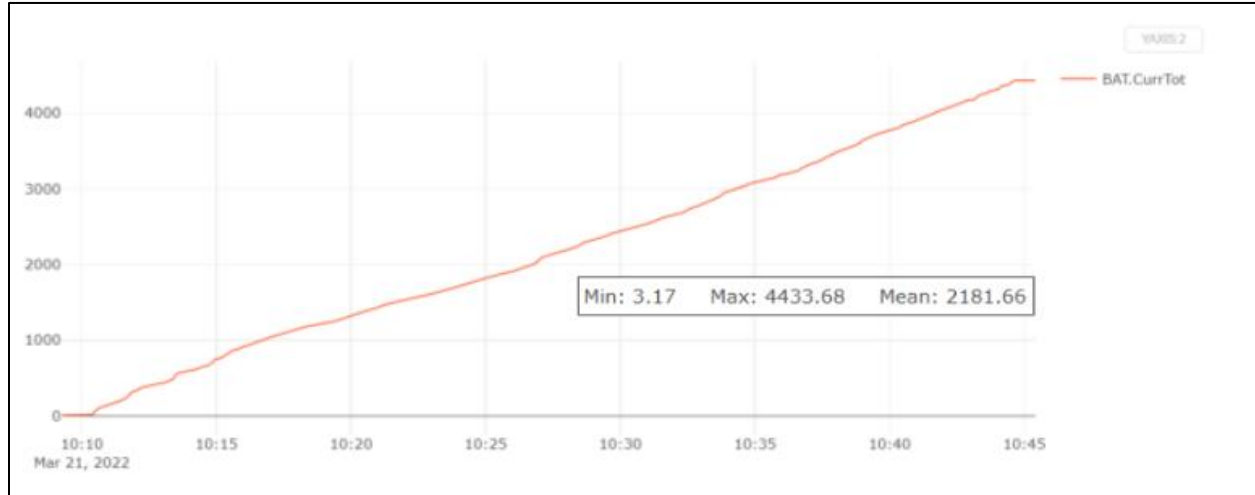

Figure 89: Power Consumption vs Flight Time

The figure above displays the total power consumption over the duration of the flight. From the plot above we can see that the max current drawn was a total of 4433.68 mA. The expected usage for was estimated to be 5500 or 55% of the max capacity of our battery which was 10000 mA (based on 15.2V). Hence, there is a variance of 20%.

9.4. Post Flight Analysis for Autonomous Flight

Based on the data that we collected along with the observations that we found during our autonomous flight, we realised that we could have flown for a much longer period. Due to it being our first autonomous flight, we were very conservative in testing and did not optimally stretch the capabilities of our system.

In the interest of prolonging the overall battery health, we decided to stop the autonomous flight at earlier than usual as we expected future testing in the future not knowing that we would be unable to conduct them as expected.

We also found that during the autonomous flight, there were times where the fixed wing drone would automatically adjust its velocity to ensure stabilized flight. This occurred frequently and it was due to the autonomous feature which utilizes the throttle to stabilize the flight. This resulted in greater current draw than expected, directly affecting the overall performance of the battery and the duration of the flight. We found that this frequently occurred during the turning phases of the routes or the waypoints.

10. Extending Future Flight Endurance

From our postflight analysis along with the analysis of our collated data, we have identified several ways in which we would be able to extend future flight endurance for future testing phases when this project is eventually handed over to future groups.

This extension of flight endurance can be separated into two different categories, one which keeps the main specifications and the other which utilizes different specifications for the overall system.

10.1. Maintaining Specifications

Using our data from our flight logs, we found that if we were to keep the same specifications and not adjust any aspect of the build whatsoever, we could potentially fly for up to an hour. This could be achieved if we managed to control the throttle speed of the autonomous aircraft.

From our analysis, we knew that the throttle speed greatly affected the current draw which ultimately affected the battery performance and the endurance of the overall system. If we were to sample the flight at a constant low throttle in 5-minute windows we would consume a total of 5700mAh.

The initial take-off and time taken for the fixed wing drone was a 40 second period which consumed a total of 160mAh. This would ultimately be the point at which the highest throttle is utilized as it occurs during take-off and will need as much power as possible to generate lift.

Hence, the total power consumption would only amount to roughly 6000mAh, (~5700+160) which estimates to be 60% discharge of the total of 10000mAh. To achieve a 60% discharge, the voltage measurement must go lower than 15.2V from a full charge of 16.8V.

Essentially this means that if we optimised the groundspeed of the fixed wing drone with low throttle and utilized the full capabilities of the battery without potentially affecting the overall battery health, we could easily achieve a total flight time of 1 hour.

This flight duration could be extended even longer if we optimised our flight path and route to ensure a wider area and lesser turns. A shorter flight path would result in more frequent and sharper turns which might utilize the increase and utilize the throttle speed more frequently which would directly affect the overall flight duration.

Additionally, if there is no concern with prolonging battery health, the battery could be brought down even further to 14.9V which is 80% discharge. This would provide us with 8000mAh to utilize for the flight which could result in even longer flight times. However, this could potentially affect the battery health over time and this practice is not recommended.

10.2. Changing Specifications

From our requirement study report, we had initially planned to utilize a Lithium-ion battery. However, due to procurement issues in Singapore, we were unable to attain this component and hence settled for Lithium Polymer option instead.

A lithium-ion battery option would allow us to save a lot more power by limiting the continuous discharge current. During take-off, it would disable high current draw. The lithium-ion battery that we selected has a max c rate which is the rate of discharge of 2.85C. It can be discharged as low as an estimated 90% of the total power which provides us with 9000mAh. This would essentially allow us to easily achieve an estimated 1.1 hours of flight times without path optimization and 1.5 hours of flight time with path optimization.

Additionally, to increase flight time, we could always reduce the overall weight of the system. This included the weight of the onboard camera. Although it was not in our scope, the surveillance capabilities of the plane were tested by attaching a GoPro Hero5 along with its mount on the front of the aircraft. This can be removed and replaced with a much lighter camera and mount. [Take note that this affects the current CG markings on the aircraft].



Figure 90: Troubleshooting during flight test

11. Summary

In summary, the overall progress of the project has led us to this stage where we have managed to successfully achieve majority of the requirements that were laid out by the stakeholders of this project.

As seen in the table below, there were 11 stakeholder requirements that we derived from the project proposal that was provided to us in the early stages of the project.

STAKEHOLDER REQUIREMENTS		
Reqmt ID	Requirement	Achieved
StRs 01	Prototype will be modeled after a fixed wing drone	Yes
StRs 02	Prototype will have an endurance operation of a minimum of 1 hour	No
StRs 03	Prototype shall be able to fly autonomously	Yes
StRs 04	System will be able to carry out surveillance	No
StRs 05	User should be able to fly the prototype manually	Yes
StRs 06	System will have launch capabilities	Yes
StRs 07	System will have recovery capabilities	Yes
StRs 08	System will be constructed within budget limitations provided by SIT	Yes
StRs 09	System will operate at the authorized drone flight height by CAAS	Yes
StRs 10	User will operate the drone within the specified frequency range by IMDA	Yes
StRs 11	System will be able to operate beyond user line of sight	Yes

Table 10: Stakeholder Requirements

We have managed to successfully fulfil 9 of these requirements while partially fulfilling the other 2 requirements. Stakeholder requirement 2 where the prototype was to have endurance of a minimum of an hour was not achieved mainly because we did not manage to carry out more testing that we planned for. With our suggestions and further testing we are highly confident that future groups would be able to fulfil these requirements.

In addition to this, we were not able to carry out surveillance as this was ultimately out of the scope of our participation in this project. This will be fulfilled by the next group taking over this project.

There are several additional suggestions that could be incorporated into the overall system that could be implemented in the near future. They are:

- Utilization of a lithium-ion battery
- Catapult Launch
- Implementation of an algorithm for autonomous landing

12. Conclusion

In conclusion, we feel that this project has ultimately provided us with the experience of applying and incorporating system engineering concepts that we have learned over the past 4 years into our project.

From the initial proposal to the derivation of requirements, conceptualization of our solution to the execution of the proposed project plan, we have managed to successfully create a fixed wing drone over the whole project life cycle.

This experience allowed us to work on both aspects of hardware and software integration. It also allowed us to practice modules such as project management, requirements engineering and system architecture, risk, and decision analysis as well as all the different systems engineering projects.

We have been incredibly fortunate to have the guidance of our supervisor Dr Wee Liang Boon as well as his fellow researchers Faheem and Murteza who we have a huge amount of respect and gratitude for. We hope that future groups taking on this project will be able to complete the whole scope with the guidance and documentation that we have provided to allow for their smooth transition.

13. References

- [1] [Online]. Available: <https://hub.digi.com/support/products/xctu/>. [Accessed 21 February 2022].
- [2] "ArduPilot," ArduPilot, [Online]. Available: <https://firmware.ardupilot.org/Tools/MissionPlanner/>. [Accessed 22 February 2022].
- [3] "QGC QGroundControl Drone Control," QGroundControl, [Online]. Available: <https://firmware.ardupilot.org/Tools/MissionPlanner/>. [Accessed 20 February 2022].
- [4] 21 02 2022. [Online]. Available: <https://www.youtube.com/watch?v=M9cbGhKUvzE&t=301s>.
- [5] "UAV Log Viewer," ArduPilot, [Online]. Available: <https://plot.ardupilot.org/#/>. [Accessed 25 March 2022].